

DL1700E Series
Digital Oscilloscope

OPERATION GUIDE

Foreword

Thank you for purchasing the DL1700E Series (DL1720E, DL1735E, DL1740E, or DL1740EL) Digital Oscilloscope.

This operation guide is designed to bring first-time users quickly up to speed with the basic operations of the DL1700E. In addition to this operation guide, the DL1700E comes with the following three manuals: the User's Manual IM701730-01E (explains all functions of the instrument), the Communication Interface User's Manual IM701730-17E, CD-ROM (provides a detailed explanation of the communication functions), and the Serial Bus Signal Analysis Function User's Manual IM701730-51E (explains the optional serial bus signal analysis function). Please refer to all of these manuals when operating the instrument.

Notes

- The contents of this manual are subject to change without prior notice as a result of continuing improvements to the instrument's performance and functions. The figures given in this manual may differ from those that actually appear on your screen.
- Every effort has been made in the preparation of this manual to ensure the accuracy of its contents. However, should you have any questions or find any errors, please contact your nearest YOKOGAWA dealer.
- Copying or reproducing all or any part of the contents of this manual without the permission of Yokogawa Electric Corporation is strictly prohibited.
- The TCP/IP software of this product and the document concerning the TCP/IP software have been developed/created by YOKOGAWA based on the BSD Networking Software, Release 1 that has been licensed from California University.

Trademarks

- Adobe, Acrobat, and PostScript are trademarks of Adobe Systems Incorporated.
- For purposes of this manual, the TM and ® symbols do not accompany their respective trademark names or registered trademark names.
- Other company and product names are trademarks or registered trademarks of their respective companies.

Revisions

1st Edition	July 2004
2nd Edition	July 2007

Contents

Foreword	1
Flow of Operation	3
Names and Functions of Front Panel Controls	4
Parts of the Screen	8
Basic Key and Jog Shuttle Operation	10
Introduction to Main Functions	12
Working with the DL1700E	16
• Preparing for an Observation	16
• Displaying a Waveform on the Screen	18
• Changing Waveform Display Conditions	19
• Changing Trigger Settings	22
• Waveform Measurement	24
• Zooming a Waveform along the Time Axis	25
• Printing and Saving a Waveform	26
Setup Menu Items	28
• CH1 to CH4(2)	28
• SETUP	29
• ACQ	29
• PRESET	30
• SIMPLE	31
• ENHANCED	32
• MODE(ACTION)	33
• POSITION(DELAY)	35
• DISPLAY(X-Y)	36
• GO/NO-GO	38
• MEASURE	39
• CURSOR	41
• MATH	42
• HISTORY	43
• ZOOM(SEARCH)	44
• COPY	46
• IMAGE SAVE	47
• FILE	47
• MISC	48

Flow of Operation

The chart below is provided to give first-time users an easy-to-understand glimpse of the overall flow of the instrument's operation. It is not intended to describe the flow of operations exactly as they are presented in this manual. For details about specific items introduced in the pages within, refer to the corresponding chapter or section in the user's manual as indicated by the arrows (▶).

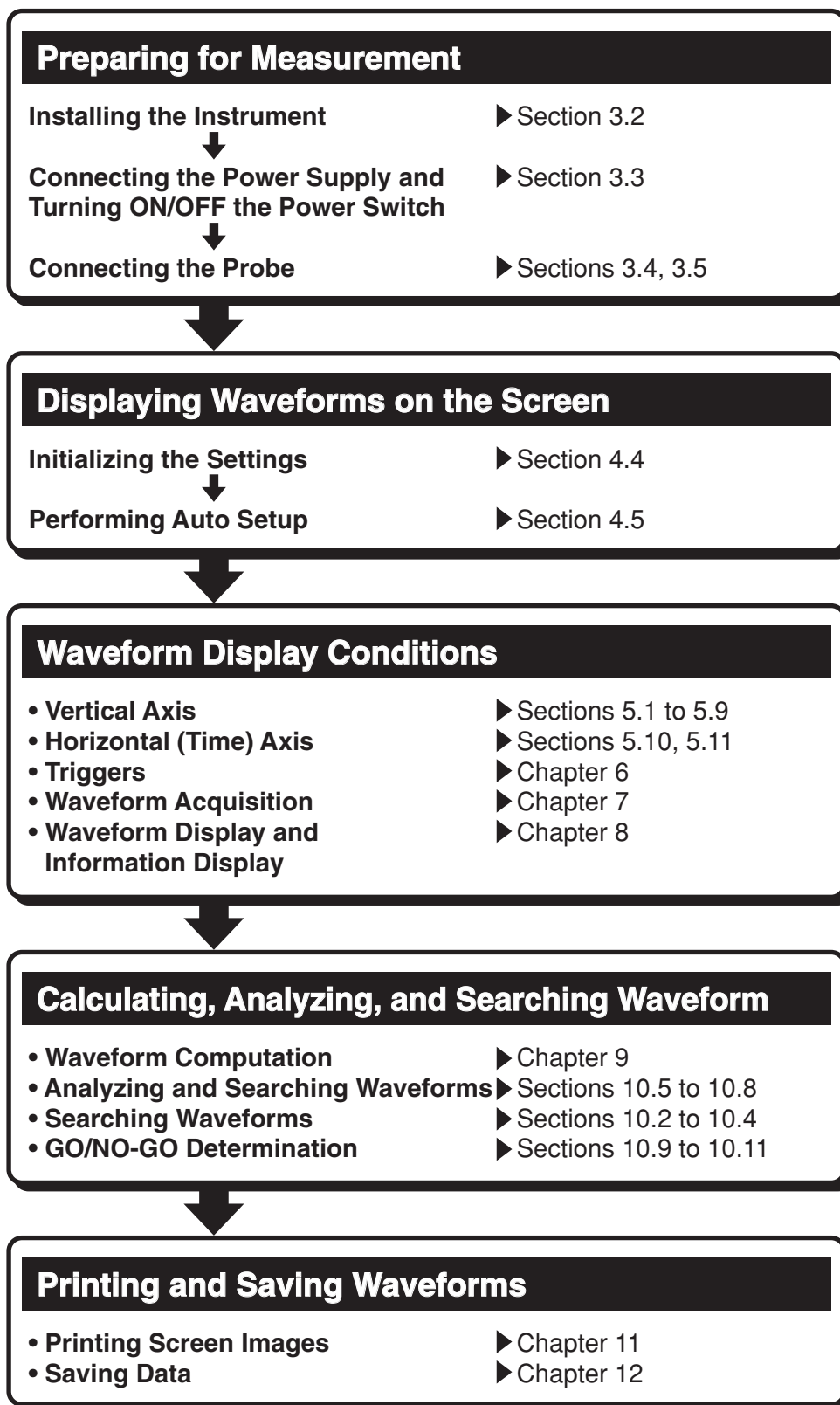

Names and Functions of Front Panel Controls

This section introduces the names of the various keys and knobs that appear on the front panel, and provides a brief explanation of what functions they control. For details about specific items introduced in the pages within, refer to the corresponding chapter or section in the user's manual as indicated by the arrows (▶).

Vertical Axis

CH1 to CH4(2)¹ keys ▶ Sections 5.1 to 5.9, 8.9
Turns the corresponding channel ON/OFF, and displays a setting menu for the channel's vertical position, coupling, probe attenuation/current-voltage conversion ratio, offset voltage, bandwidth limit, vertical axis zoom, linear scaling, and waveform labels. Pressing a channel key displays the channel's menu. If you then turn the V/DIV knob, the V/DIV setting will apply to that channel. The indicator to the left of each channel key illuminates when the channel's display is ON.

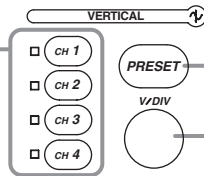

PRESET key ▶ Sections 5.7
Displays a menu for automatically setting the probe attenuation/current-to-voltage conversion ratio, V/div, offset voltage, trigger level and other items to CMOS or ECL signal values (or other desired values). Presets can also be assigned to all channels at once.

V/DIV knob ▶ Sections 5.2
Sets the vertical sensitivity². Before turning the knob, you can press a CH1–CH4(2) key to select the channel and display its menu. If you change the vertical axis sensitivity setting while waveform acquisition is stopped, the new setting takes effect when you start waveform acquisition again.

1. There are two channel keys (CH1 to CH2) on the DL1720E and four channel keys (CH1 to CH4) on the DL1735E/DL1740E/DL1740EL. The notation CH1 to CH4(2) is used in this manual to indicate that CH1 to CH2 or CH1 to CH4 can be controlled or configured on the DL1720E and the DL1735E/DL1740E/DL1740EL, respectively.
2. In the probe attenuation ratio/current-to-voltage conversion ratio settings, the voltage axis sensitivity is set when setting the probe attenuation ratio, and the current axis sensitivity is set when setting the current-to-voltage conversion ratio.

Horizontal Axis

(SHIFT+) ZOOM key ▶ Sections 8.4 and 10.4
Displays a menu for waveform zoom settings. If you press the SHIFT key followed by the ZOOM key, a menu for setting waveform search conditions (the Search and Zoom function) is displayed.

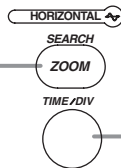

TIME/DIV knob ▶ Section 5.11
Sets the horizontal axis (time axis) scale. If you change the setting while the waveform acquisition is stopped, the new setting takes effect when you start waveform acquisition again.

Triggers

TRIG'D indicator
Illuminates when a trigger has been activated.

SIMPLE key ▶ Sections 6.5 to 6.7
Displays a menu for setting a simple trigger, which is usually the edge trigger. The indicator to the upper left of the SIMPLE key illuminates when the simple trigger is active.

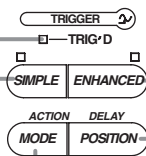

ENHANCED key ▶ Sections 6.8 to 6.14
Displays a setting menu for enhanced triggers such as the pattern trigger or other complex triggers. The indicator to the upper right of the ENHANCED key illuminates when the enhanced trigger is active.

(SHIFT +) POSITION key ▶ Sections 6.2 and 6.3
Displays a setting menu for the trigger position. If you press the POSITION key while holding down the SHIFT key, a setting menu is displayed for the trigger delay.

(SHIFT +) MODE key ▶ Sections 6.1, 6.15 and 7.6
Displays a setting menu for trigger modes and sequential store. If you press the MODE key while holding down the SHIFT key, a setting menu is displayed for the action on trigger.

Common Operations and Acquisition, Display, Calculation, Analysis, and Searching

GO/NO-GO key ▶ Sections 10.9 and 10.10
Displays a setting menu for GO/NO-GO determination.

HISTORY key ▶ Sections 10.1 to 10.3
Displays a setting menu for displaying and searching waveforms using the History memory function. Waveforms that have been sequentially stored can also be displayed and searched.

CURSOR key ▶ Section 10.5
Displays a setting menu for cursor measurement.

(SHIFT +) MATH key ▶ Sections 9.1 to 9.8
Displays a setting menu for waveform calculations. If you press the MATH key while holding down the SHIFT key, a setting menu is displayed for the phase shift.

ACQ key ▶ Sections 5.11, and 7.2 to 7.5
Displays a setting menu for the record length, acquisition mode, interleave mode, sampling mode, and time base during waveform acquisition.

START/STOP key ▶ Section 7.1
Starts/stops waveform acquisition according to the trigger mode. The indicator above the START/STOP key illuminates when waveforms are being acquired.

RESET key
Restores a value changed using the jog shuttle to its original setting.

ESC key
Use this key to close soft key menus and dialog boxes.

SELECT key
Enters a value set using the jog shuttle.

Jog shuttle
Used in many operations to select setting values and move cursors. The angle through which the shuttle ring is rotated determines the rate at which the setting values increment or decrement.

Arrow keys (< >)
Changes the currently selected digit when entering values with the jog shuttle. Used to change setting values and move cursors.

SHIFT key
Pressing the SHIFT key causes the SHIFT lamp above the key to illuminate, indicating that the instrument has entered SHIFT mode. The setup menu marked in purple above or below the

(SHIFT +) DISPLAY key ▶ Sections 8.1 to 8.3, 8.5, and 8.7 to 8.10
Displays a setting menu for display of waveforms and their information. If you press the DISPLAY key while holding down the SHIFT key, a setting menu appears for X-Y display.

SETUP key ▶ Sections 4.4, 4.5, and 12.1
Displays an auto setup menu for automatically assigning values from the input signal to settings, the Initialize menu for restoring factory default settings, and the Store/Recall settings menu.

MEASURE key ▶ Sections 10.6 to 6.8
Displays a menu for automatic measurement of waveform parameters and statistical processing.

Printing Screen Images and Saving/Loading Data

FILE key ▶ Sections 12.2 to 12.8 and 12.11 to 12.13
Displays a menu used when saving data to or loading data from a storage medium (internal storage media, external USB storage devices, or network drives). You can also use this key to display thumbnails of saved screen images.

(SHIFT +) COPY key ▶ Chapter 11
Used to print screen images on the built-in printer, a USB printer, or a network printer. If you press the PRINT key while holding down the COPY key, a setting menu appears for printing screen images.

(SHIFT +) IMAGE SAVE key ▶ Sections 12.9 and 12.10
Used to save screen images to storage media. If you press the IMAGE SAVE key while holding down the SHIFT key, a setting menu appears for saving screen images to storage media. You can also use this key to display thumbnails of saved screen images.

■ Calibration, Ethernet Communications, and Other Operations ■

MISC key ▶ Sections 3.6, 4.6, 4.7, 6.16, 16.3 and 16.4, and chapters 13 and 15 of the Communications User's Manual

Displays a menu for settings related to the date/time, calibration, trigger gate, Ethernet communications, message and menu language, click sound ON/OFF, USB keyboard language, use of offset voltage measurement/calculation results, screen colors/brightness, backlight, self test, and remote control. It can also be used to display settings and system information (options installed on the unit, firmware version etc.).

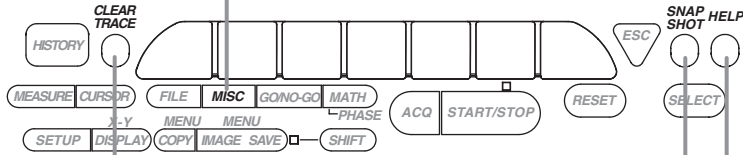

CLEAR TRACE key ▶ Section 8.6
Clears snapshot waveforms and accumulated waveforms.

HELP key ▶ Section 4.8
Turns the help window, which provides explanations of operations, ON and OFF.

SNAP SHOT key ▶ Section 8.6
Displays a non-updating copy of the currently displayed waveform on the screen in white (default setting).

MEMO

Parts of the Screen

This section introduces the menus and symbols appearing on the DL1700E screen. For details about specific items introduced in the pages within, refer to the corresponding chapter or section in the user's manual as indicated by the arrows (▶ or ●●●▶).

Common Parts of the Screen

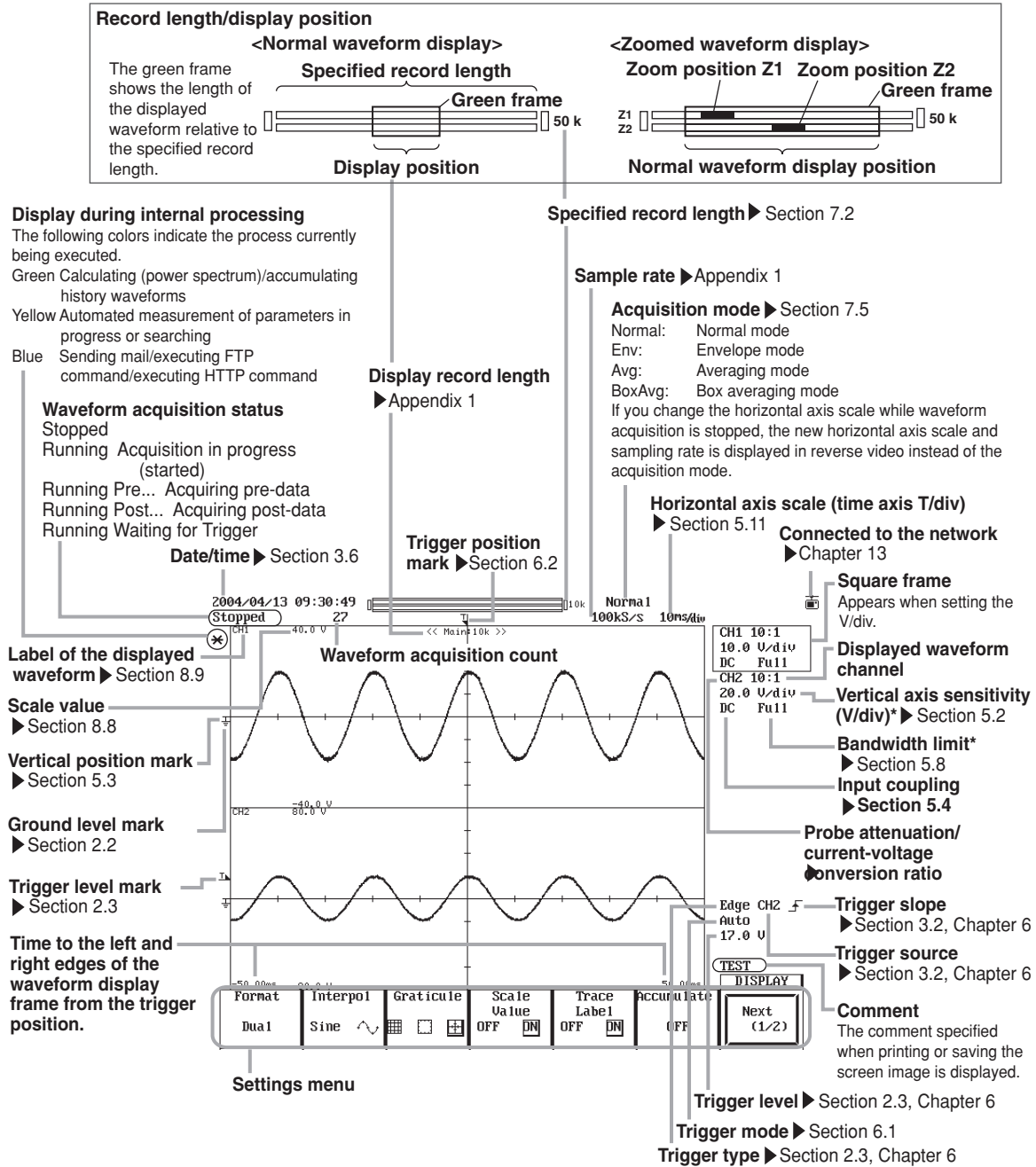

* If you change the vertical axis sensitivity while waveform acquisition is stopped, the new vertical axis sensitivity is displayed in reverse video instead of the input coupling and bandwidth limit.

Screen When Displaying Zoomed Waveforms

●●●▶ User's manual section 8.4, "Zooming the Waveform"

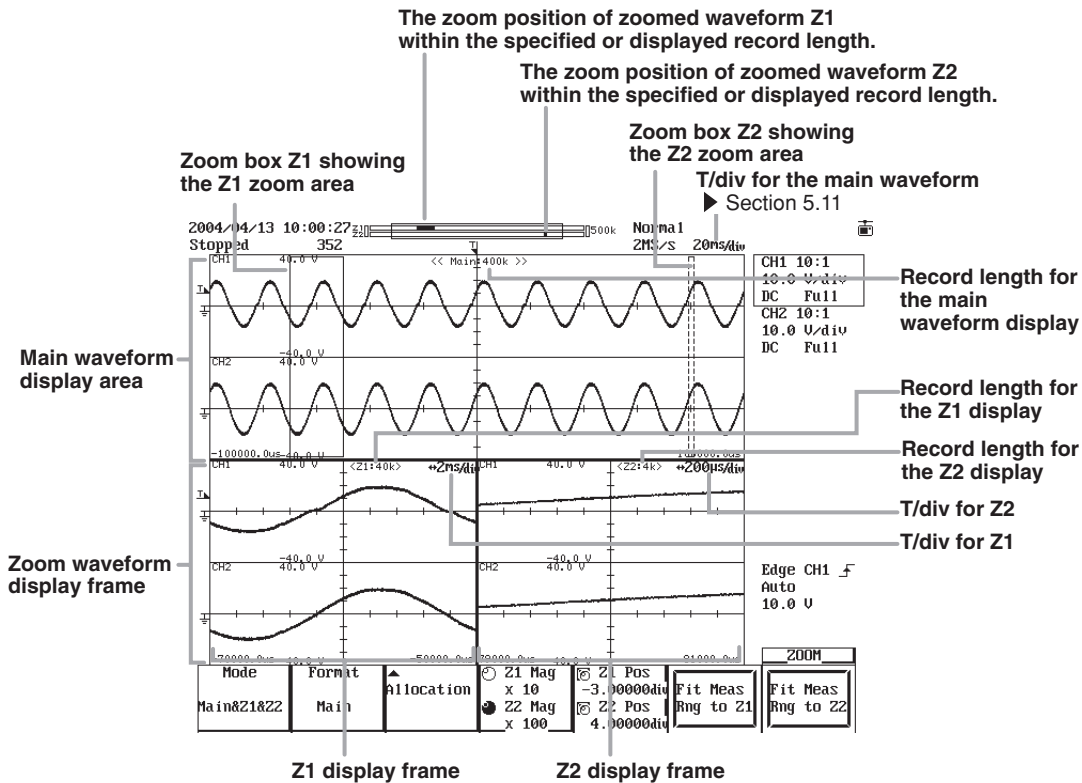

Screen When Displaying X-Y Waveforms

●●●▶ User's manual section 8.5, "Displaying the X-Y Waveform"

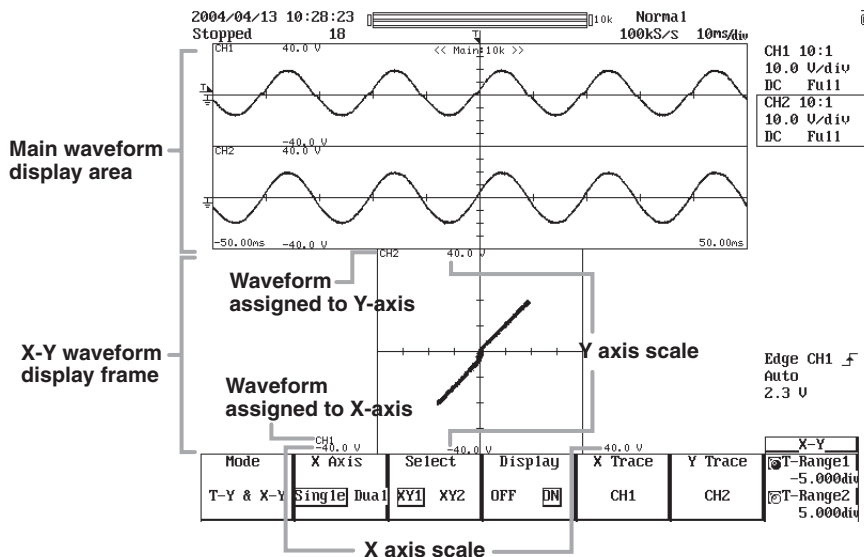

Basic Key and Jog Shuttle Operation

This section explains the basics of using the keys and jog shuttle for entering settings on the DL1700E.

Basic Key Operation

Working with the Setup Menu

ACQ menu (the menu displayed by pressing the ACQ key)

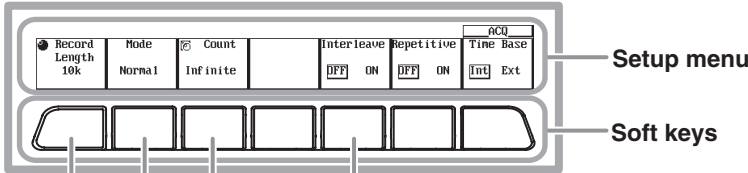

Selecting items by using the soft keys

Each time you press the soft key, the selection item changes. The selected item is highlighted.

Entering values by using the jog shuttle (in menus with the and icons)

Press the soft key to enable the jog shuttle (:enabled, :disabled). Turn the jog shuttle to select a value. Use the arrow key to change the selected digit.

Selecting items by displaying a selection menu

Press a soft key to display the corresponding selection menu. Press the soft key corresponding to the desired selection.

Selecting items by using the jog shuttle (in menus with the and icons)

Press the soft key to enable the jog shuttle (:enabled, :disabled). Turn the jog shuttle to change the setting.

Note

How to Display the Setting Menu for the Functions Labeled in Purple

Press the SHIFT key (causing the SHIFT indicator to the left of the key to illuminate), then press a key labeled with purple characters to display the corresponding menu.

Working with Dialog Boxes

The delay setup dialog box

(Appears when pressing the MEASURE key, then turning the mode ON and pressing the Delay Setup soft key in the setting menu that is displayed.)

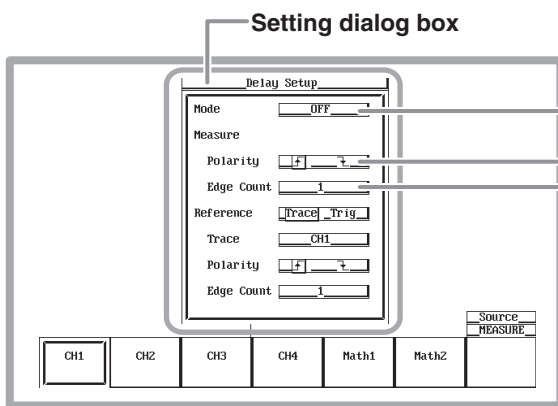

Use the jog shuttle to select the desired setting.

Press the SELECT key to display the selection menu. Turn the jog shuttle to move the cursor to the desired setting. Press the SELECT key to enter the desired setting.

Each time you press the SELECT key, the selection item changes.

Press the SELECT key to display the numerical value input box.

Turn the jog shuttle to select a value. Use the arrow key to change the selected digit.

When mode is selected When edge count is selected

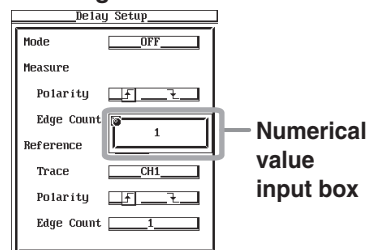
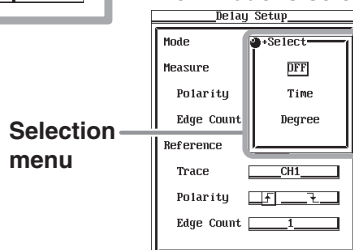

Note

To close a setting menu or dialog box from the screen, press the ESC key.

Basic Jog Shuttle Operation

Selecting an Item

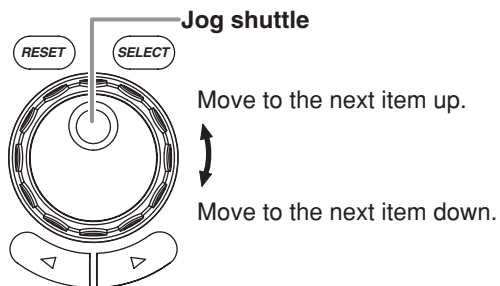

Entering Numerical Values

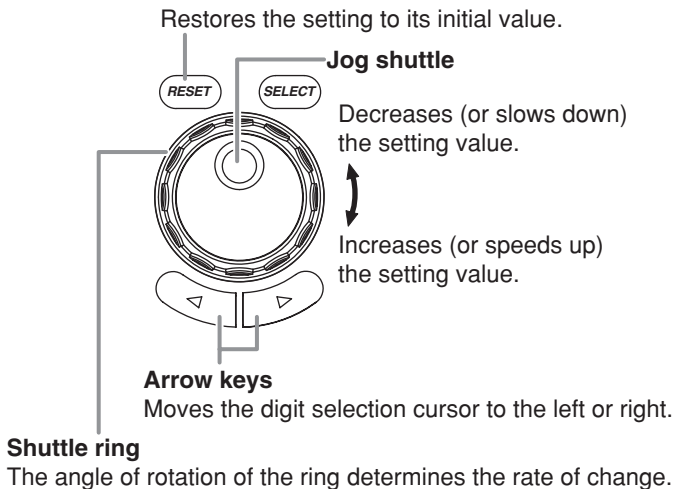

Tips

Using a USB Mouse

●●●▶ User's manual section 4.3, "Operating the Instrument Using a USB Keyboard or USB Mouse."

If you connect a USB mouse to the USB PERIPHERAL connector on the rear panel of the DL1700E, you can use the mouse to perform the same operations available with the front panel keys.

USB PERIPHERAL connector (rear panel)

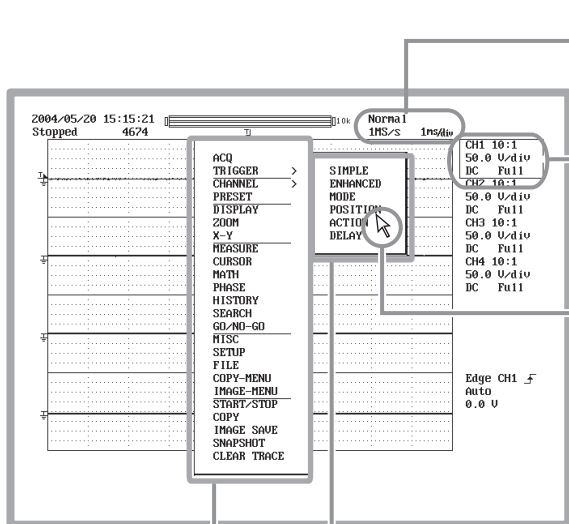
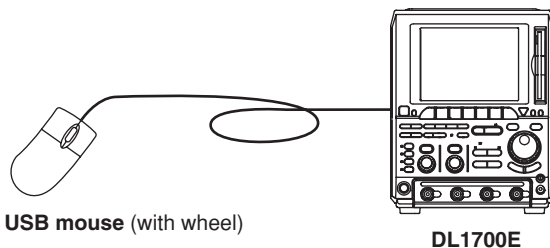

If you move the mouse pointer to this position, the pointer changes from a to a . In this mode, if your mouse has a wheel you can use it to change the T/div setting.

If you move the mouse pointer to this position, the pointer changes from a to a . In this mode, if your mouse has a wheel you can use it to change the V/div setting.

Pointer
Move the pointer to the desired item, click it, and the corresponding setup menu appears.

Sub menus
A sub menu is displayed when clicking on a top menu item accompanied by an arrow (>).

Top menu
Right click in the display (waveform display frame) to display the top menu containing all the names of the front panel keys.

Introduction to Main Functions

Triggers

• • • ▶ User's manual Chapter 6, "Triggers"

There are two main categories of triggers: simple triggers and enhanced triggers.

Simple triggers

Edge trigger

If the signal input to the measurement input terminal passes through the specified trigger level (on the rising or falling edge, or both edges), the trigger activates.

External trigger

If the signal input to the EXT TRIG IN terminal (or the EXT terminal on the DL1720E) passes through the specified trigger level (on the rising or falling edge, or both edges), the trigger activates.

Commercial power trigger

A trigger activates on the rising or falling edge of the waveform from the commercial power being supplied to the DL1700E.

Enhanced triggers

A->B(N) trigger

A trigger activates the Nth time condition B becomes true after condition A becomes true.

A Delay B trigger

After condition A becomes true, a trigger activates once condition B becomes true after a specified time has elapsed.

Pattern trigger

A trigger activates when all of the trigger conditions from several trigger sources* are met or not met.

Width trigger

A trigger activates depending on whether the conditions became true or not for a shorter or longer duration than a specified reference time.

OR trigger

A trigger activates when at least one of the trigger conditions from several trigger sources is met.

Window trigger

A trigger activates when a trigger source enters or exits a "window" specified by two voltage levels.

TV trigger

A trigger activates on the video signal being input to CH1.

* A trigger source is a signal to which trigger activation conditions are applied.

History Memory

• • • ▶ User's manual section 10.1, "Displaying History Waveforms"

When measuring waveforms, numerical data is being loaded into the acquisition memory, and that data can be viewed on the DL1700E screen as a waveform. When taking continuous measurements, even if you stop measurement when you see an abnormal waveform, the waveform has already scrolled off the screen. Normally, you cannot go back and view the abnormal waveform. But with the history memory function, you can display past waveform data that has been loaded into the acquisition memory while measurement is stopped. You can displayed a specific waveform from among a maximum of 2048 "history waveforms."

Also, you can search for history waveforms passing or not passing through a specified search zone (zone search), or ones that meet or do not meet specified parameter conditions (waveform parameter search).

• Zone search

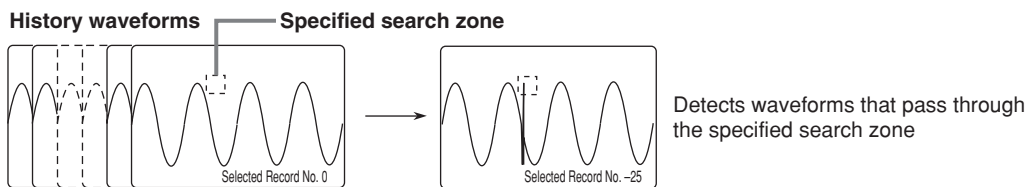

• Waveform parameter search

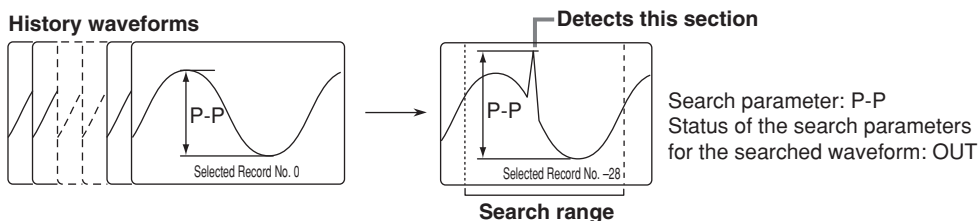

Changing the Record Length

● ● ● ▶ [User's manual section 7.2, "Setting the Record Length"](#)

The term record length refers to the number of data points acquired per channel in the acquisition memory. Setting the record length long allows either longer observations or data sampling at higher sampling rates. Waveforms that could not be captured with shorter record lengths can not be accurately observed.

The record length can be adjusted using the Record Length setting under the ACQ menu (see page 29 of this manual).

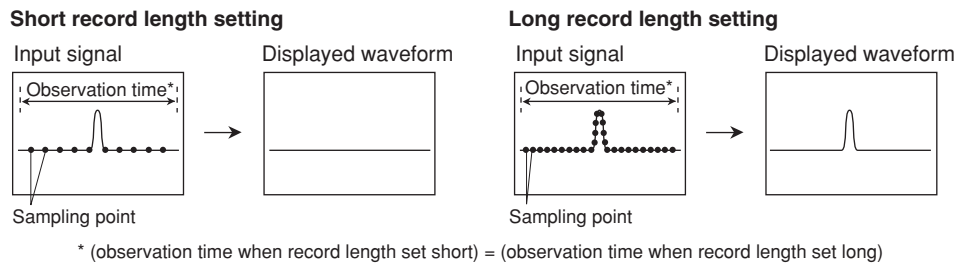

Zooming a Waveform along the Horizontal (Time) Axis

● ● ● ▶ [User's manual section 8.4, "Zooming the Waveform"](#)

You can expand (zoom) a displayed waveform along the time axis. Two areas of a waveform can be zoomed at the same time. This function is useful when you want to observe one part of a waveform in detail that was acquired over a long period of time. You can specify the area to be zoomed or the zoom position (position of the zoom box).

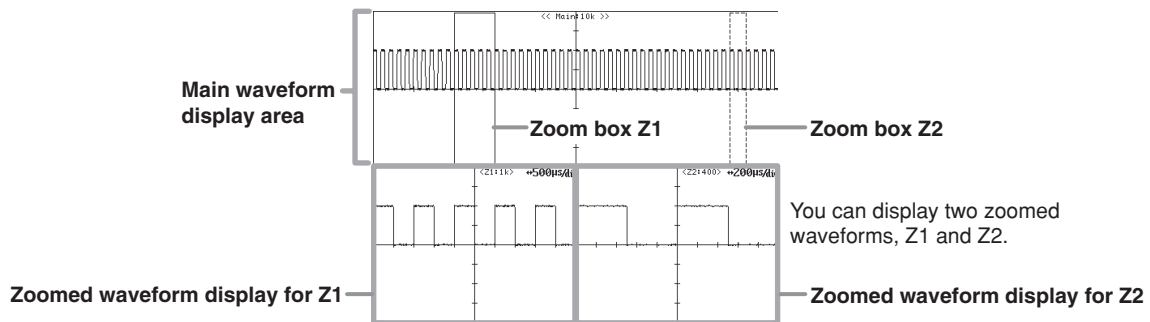

X-Y Waveform Display

● ● ● ▶ [User's manual section 8.5, "Displaying the X-Y Waveform"](#)

This function takes the signal level of the specified waveform assigned to the X-axis (horizontal axis), and the signal level of another waveform assigned to the Y-axis (waveform for which display is ON), and displays the relationship between the two. You can observe an X-Y waveform and the normal T-Y waveform (waveform based on the time axis and signal level) simultaneously. Up to 2 X-Y waveforms can be displayed on the screen.

Search and Zoom

● ● ● ▶ [User's manual section 10.4, "Searching Waveforms Using the Search and Zoom Function"](#)

Searches for waveforms matching search conditions, and zoom-displays them. The following five search modes are available.

Edge

Performs a search based on the number of times that a waveform falls below or above (rising/falling) a specified level.

Serial pattern

Performs a search based on whether the serial status pattern of the waveform (the status pattern of the waveform that changes over time) is High (H), Low (L), Don't care (X), and whether it is the same as a specified pattern.

Parallel pattern

Performs a search based on whether the parallel status pattern of the waveform (the status pattern of the waveforms at the same point in time) is High (H), Low (L), Don't care (X), and whether it is the same as a specified pattern.

Pulse width

Searches for waveform pulses lying above or below a specified level whose widths are of shorter or longer duration than a specified time.

Auto scroll

The zoom position automatically moves in the specified direction. You can watch the zoomed waveform as it scrolls, then stop it at any desired position.

Waveform Computation

●●●▶ [User's manual chapter 9, "Waveform Computation"](#)

The following operations are available: arithmetic (+, -, ×), binarization, inversion, differentiation/integration, phase shift, and power spectrum calculation (FFT).

Cursor Measurements

●●●▶ [User's manual section 10.5, "Cursor Measurements"](#)

You can place cursors on a waveform to display the measured values at the points where the cursor intersects with the waveform. There are four types of cursor available: horizontal, vertical, marker, and angle cursor.

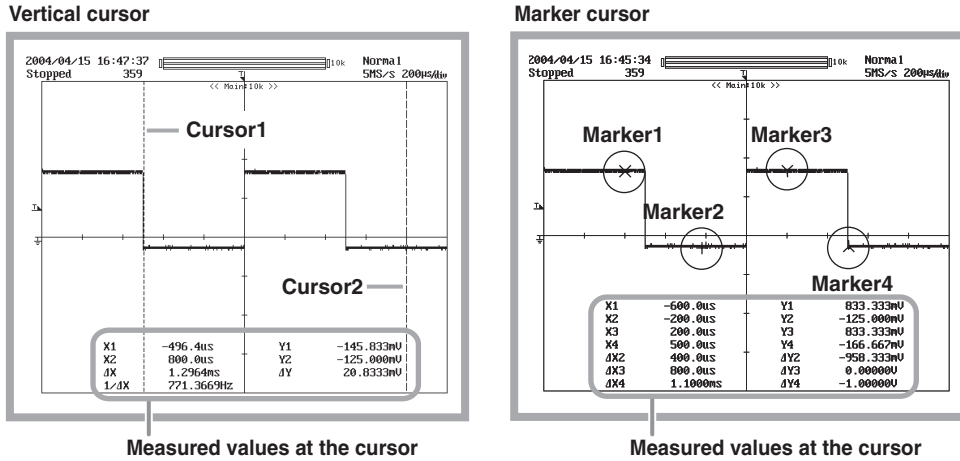

Automatic Measurement of Waveform Parameters

●●●▶ [User's manual section 10.6, "Automated Measurement of Waveform Parameters"](#)

This function automatically measures certain properties of a waveform such as the maximum level and frequency. There are twenty-seven parameters that can be measured (including between-waveform delay). Up to twelve of those parameters can be displayed on the screen. From all waveforms, up to 24000 data items total can be saved to a storage medium.

Measurement parameter related to the vertical axis (10)	Measurement parameters related to the time axis (12)	Measurement parameters related to the area (4)	Delay between waveforms (1)
<ul style="list-style-type: none"> • P-P • Min • Rms • High • +OShot • Max • Avg • Sdev • Low • -OShot 	<ul style="list-style-type: none"> • Freq • Rise • +Width • Duty • Burst2 • AvgFreq • Period • Fall • -Width • Burst1 • Pulse • AvgPeriod 	<ul style="list-style-type: none"> • Int1TY • Int1XY • Int2TY • Int2XY 	<p>Measured items having to do with the time difference between the rising and falling of the target waveform relative to a reference waveform or trigger point.</p>

Statistical Processing

●●●▶ [User's manual section 10.7, "Statistical Processing of the Automated Measurement Values of Waveform Parameters"](#)

You can perform five statistical processes on the automatically measured values of waveform parameters: maximum value, minimum value, average, standard deviation, and the count of measured values used in the statistics. The following three types of statistical processing are available.

Normal measurement/statistical processing

During measurement, all waveform data acquired up to the current time are measured for the selected measurement item and statistics are calculated.

Measurement per cycle/statistical processing within the measurement range

Waveforms are delimited every cycle from the left side of the screen to the right (oldest to youngest), each cycle is measured for the selected measurement item, and statistics are calculated.

Measurement and statistical processing of history waveforms

History waveforms are measured for the selected measurement item, and statistics are calculated. Measurement and statistics are taken starting with the oldest waveforms.

GO/NO-Go Determination

● ● ● ►  User's manual section 10.9, "Performing GO/NO-GO Determination Using Zones," and section 10.10, "Performing GO/NO-GO Determination Using Automated Measurement of Waveform Parameters."

This function determines whether a waveform enters or does not enter a specified range, and then performs (GO) or does not perform (NO-GO) a certain action. Determinations are made by specifying a zone on the on-screen waveform, or specifying a waveform parameter range.

The GO/NO-GO actions include sounding a buzzer, saving data, printing a screen image, and sending an e-mail message (with the /C10 option installed).

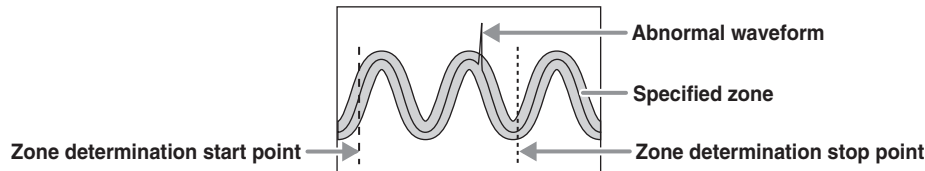

Snapshot

● ● ● ►  User's manual section 8.6, "Taking Snapshots and Clearing Traces"

When not in Single or Single(N) mode, the displayed waveform is periodically updated or displayed in roll mode. Using the Snapshot function, you can temporarily freeze a waveform on the screen that would ordinarily be lost when the screen is updated. Snapshot waveforms are displayed in white, allowing you to easily compare them with the updated waveforms. Furthermore, you can save snapshot waveforms to a memory medium, or print them out as screen images.

Pressing the SHIFT key followed by the SNAP SHOT key clears only the snapshot waveforms.

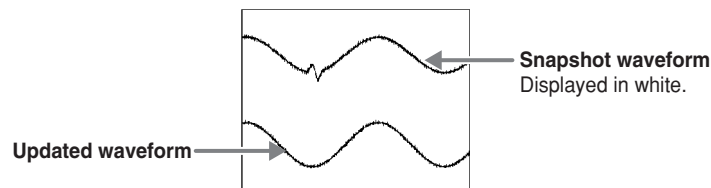

Ethernet Communications

● ● ● ►  User's manual chapter 13, "Ethernet Communications (Optional)"

You can transmit data or control the DL1700E using the Ethernet (available with the /C10 option).

Saving and loading data to and from a network drive

You can save or load data and screen images to and from an FTP server* on a network in the same way that you can using the internal storage medium or USB storage device.

* A PC or workstation running the FTP server function

Printing to a network printer

Screen images can be printed to a network printer in the same manner as they are printed to the built-in printer (optional) or USB printer.

Mail transmission

You can have the DL1700E send a mail at regular intervals containing its current settings and measured values. You can also have mail sent based on a GO/NO-GO determination or upon activation of an acquisition trigger that contains the trigger time and other information.

Accessing the DL1700E from a PC or workstation

You can access the DL1700E from any FTP client* on the network, and obtain files from the instrument's internal storage medium or external USB storage devices.

* A PC or workstation running the FTP client function

Web server

You can set up the DL1700E as a Web server. From the DL1700E Web page, you can transmit files, monitor the displayed waveform, perform basic setting operations on the instrument, and obtain waveform data.

Working with the DL1700E

This section provides an example of how you can observe a probe compensation signal being output from the DL1700E.

Preparing for an Observation

Connecting the Power Supply

●●●▶  User's manual section 3.3, "Connecting the Power Supply and Turning the Power Switch ON and OFF"



Before connecting the power supply, you must read the warnings in the user's manual listed in section 3.3, "Connecting the Power Supply and Turning the Power Switch ON and OFF."

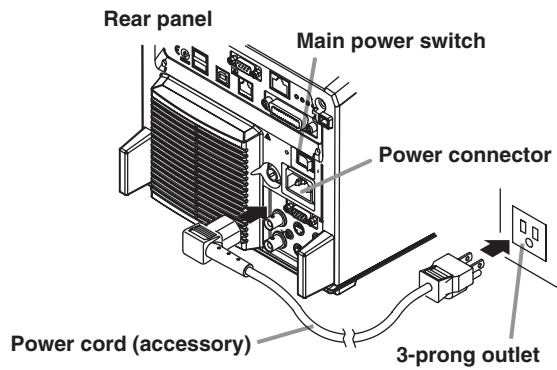

Rated supply voltage:	100–120 VAC/200–240 VAC
Rated supply voltage range:	90–132 VAC/198–264 VAC
Rated power supply frequency:	50/60 Hz
Permitted power supply frequency range:	48 to 63 Hz

Turning ON the Main Power Switch

●●●▶  User's manual section 3.3, "Connecting the Power Supply and Turning the Power Switch ON and OFF"

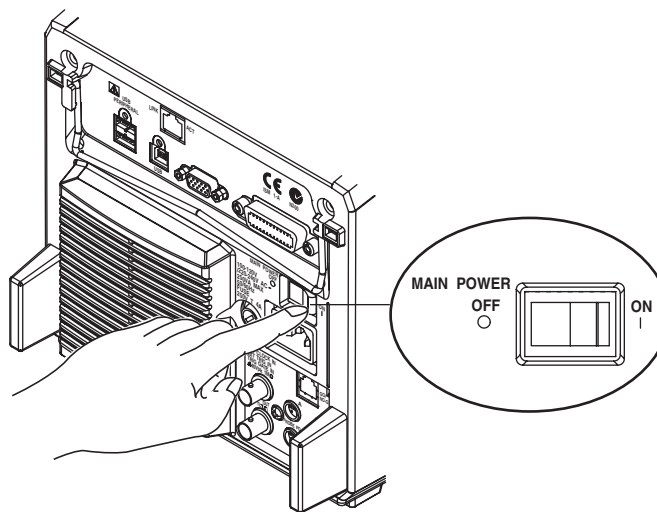

Turning ON the Main Power Switch

●●●▶  User's manual section 3.3, "Connecting the Power Supply and Turning the Power Switch ON and OFF"

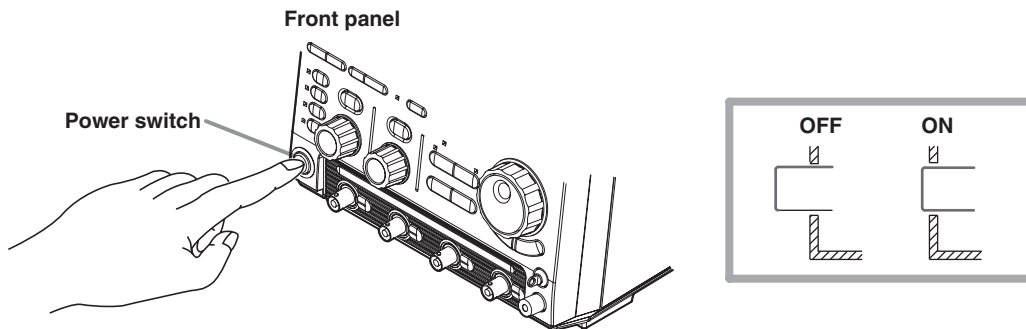

Connecting the Probe

●●●▶  User's manual section 3.4, "Connecting a Probe," and section 3.5, "Compensating the Probe (Phase Correction)."



Before connecting the probe, you must read the warnings in the user's manual listed in section 3.4, "Connecting a Probe" and section 3.5, "Compensating the Probe (Phase Correction)."

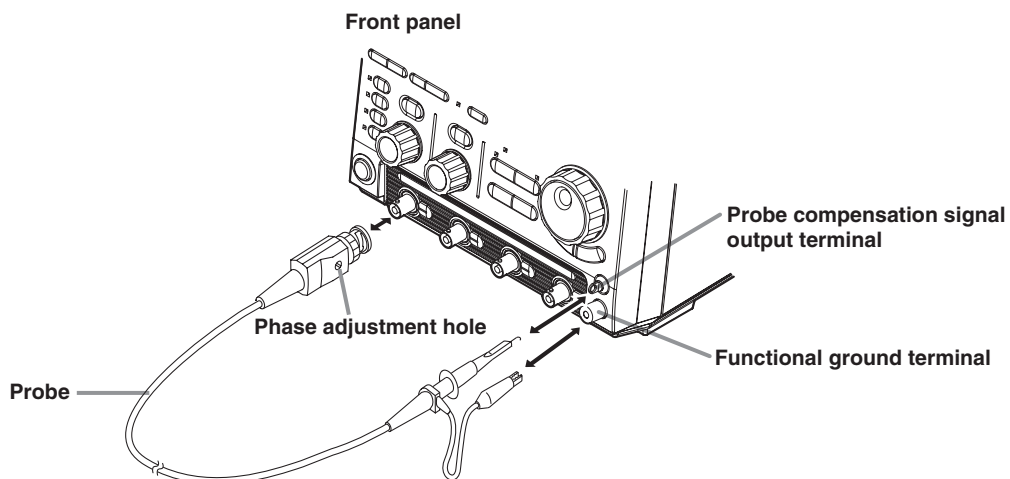

Note

When actually making waveform observations using the probe, you must follow the procedures in the user's manual for probe phase correction (section 3.5), and calibration (section 4.6). Failure to use the probe correctly will result in incorrect waveforms.

Displaying a Waveform on the Screen

This section explains how to perform convenient, basic setting initialization and auto setup when you want to display common repeating waveforms such as sine waves and square waves.

Initializing Settings

●●●▶ User's manual section 4.4, "Initializing Settings"

The procedure below restores the settings that are controlled by the front panel keys to their factory default values. If this is your first time to use the instrument the procedure is not necessary, but performing the procedure now will help you remember it for future reference. This initialization procedure is also useful when reentering settings to match the input signal.

1 SETUP

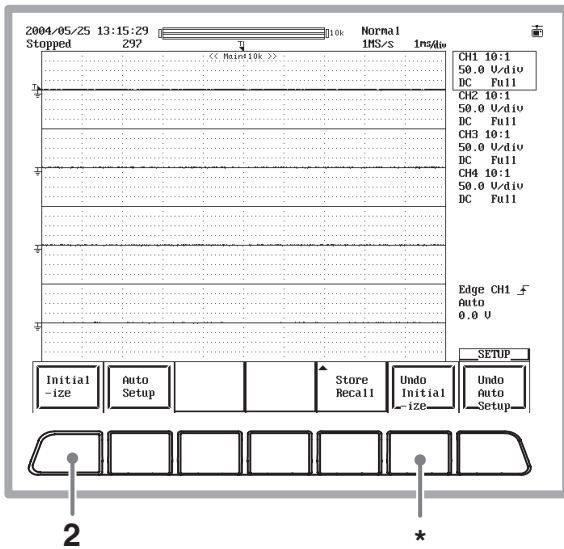

1 Press the SETUP key.

2 The initialization executes.

* To restore the settings prior to initialization, press this button.

Note

- After initialization, the display for all channels is turned ON, and the instrument enters the START condition.
- Items that are not subject to initialization using the soft key procedure are the following: **Date/time setting, communication settings, stored settings, and language settings.**

To initialize all settings except the date/time setting, perform the procedure below. Note that settings cannot be restored after this procedure. Turn the power switch ON while holding down the RESET key.

Auto Setup

●●●▶ User's manual section 4.5, "Executing Auto Setup"

You can automatically enter vertical axis, horizontal axis, and trigger settings to match the input signal. This function is useful when you just want to quickly display the signal in order to determine what kind of signal it is and what sort of settings might be required to measure it.

1 SETUP

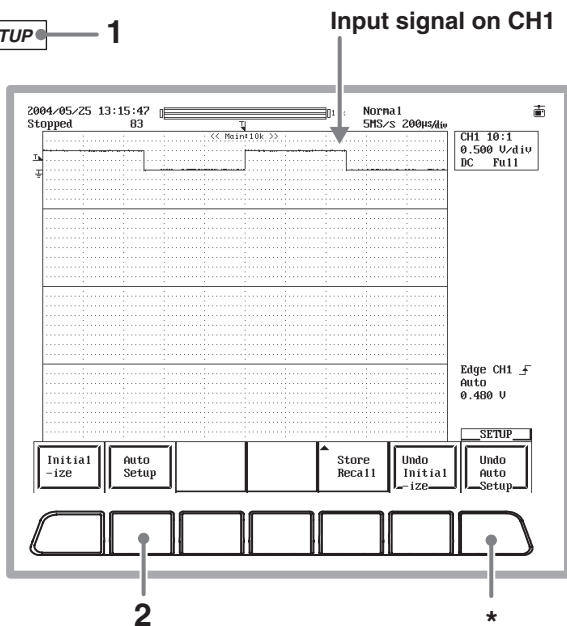

1 Press SETUP.

2 Auto setup executes.

* To restore the settings prior to auto setup, press this soft key.

Note

- When you execute auto setup, only the display of the channel on which the signal is being input is ON.
- The waveforms on which auto setup can be performed must have the following properties:
 Frequency: approximately 50 Hz or higher
 Absolute value of input voltage: max. value of 20 mV (1:1) or more
 Type: repeating wave (non-complex)

Changing Waveform Display Conditions

This section explains how to split the screen, and how to change settings such as the voltage or vertical axis sensitivity and vertical position, or the time or horizontal axis.

Setting the Screen Divisions to Single

●●●▶ User's manual section 8.1, "Changing the Display Format"

The default number of screen divisions is four (Quad). In this case we only want to observe channel 1 so we change the setting to Single (1 screen division).

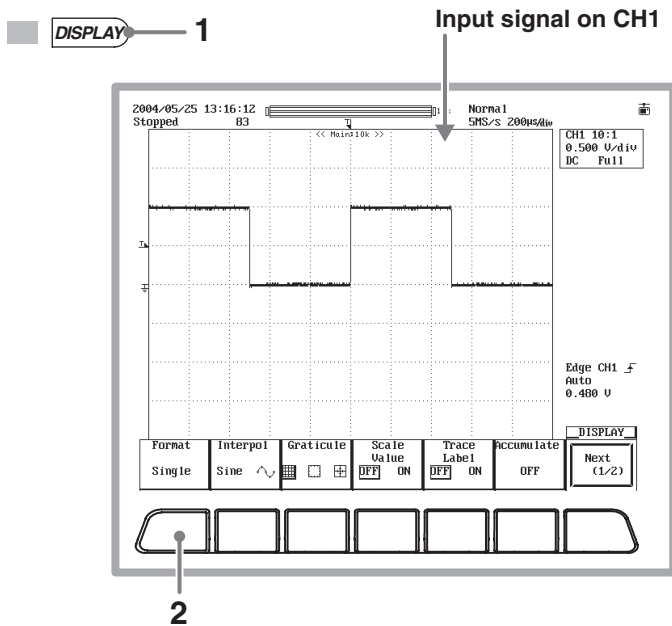

1 Press the Display key.

2 Open the selection menu, then choose Single.

Changing the Voltage Axis Sensitivity Setting from 0.5 V/div to 0.2 V/div

●●●▶ User's manual section 5.2, "Setting V/div"

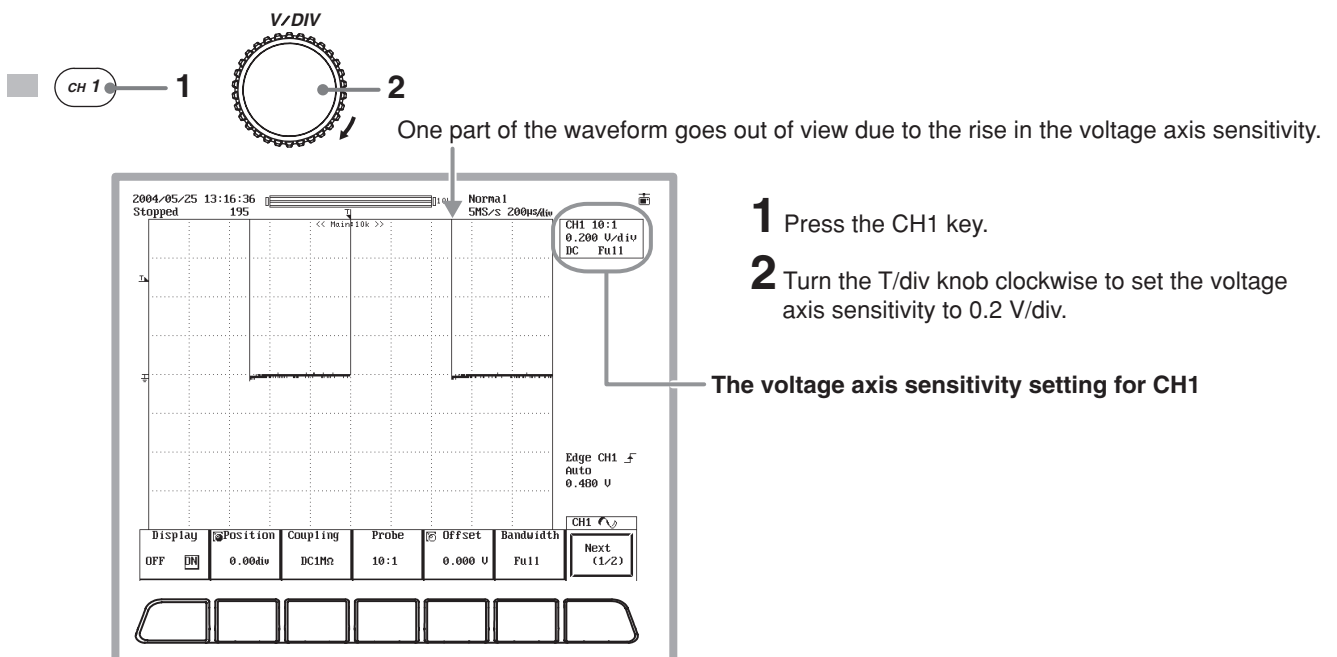

1 Press the CH1 key.

2 Turn the T/div knob clockwise to set the voltage axis sensitivity to 0.2 V/div.

The voltage axis sensitivity setting for CH1

Bringing the Waveform's Entire Amplitude into View by Lowering the Vertical Axis Position

●●●▶ [User's manual section 5.3, "Setting the Vertical Position of the Waveform"](#)

CH 1 1

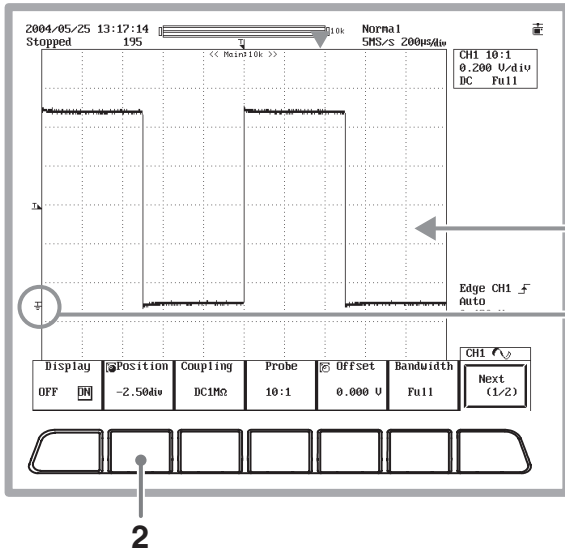

- 1 Press the CH1 key.
- 2 Turn the jog shuttle counterclockwise to set Position to -2.50 div.

Lowering the position of the vertical axis allows the entire amplitude of the waveform to be displayed.

The ground level mark is also moved.

Changing the Time Axis Setting from $200 \mu\text{s}/\text{div}$ to $100 \text{ms}/\text{div}$

●●●▶ [User's manual section 5.11, "Setting T/div"](#)

The time axis setting is the setting for the amount of time per grid division.

If you slow (increase the value of) the time axis setting, the display is updated according to triggers, so the instrument changes from update mode to roll mode in which the waveform scrolls from the right to left side of the screen.

Roll mode is useful when you want to observe signals with long periods or signals that change slowly.

TIME/DIV

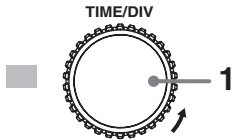

Roll mode display
Time axis setting

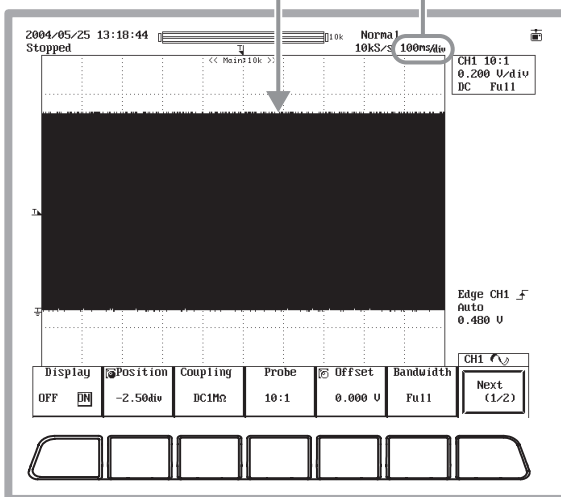

- 1 Turn the TIME/DIV knob counterclockwise to set the time axis setting to $100 \text{ms}/\text{div}$.

■ Changing the Time Axis Setting from 100 ms/div to 500 μ s/div ■

●●●▶  User's manual section 5.11, "Setting T/div"

The display reverts from roll mode back to update mode, and five periods worth of the waveform is displayed.

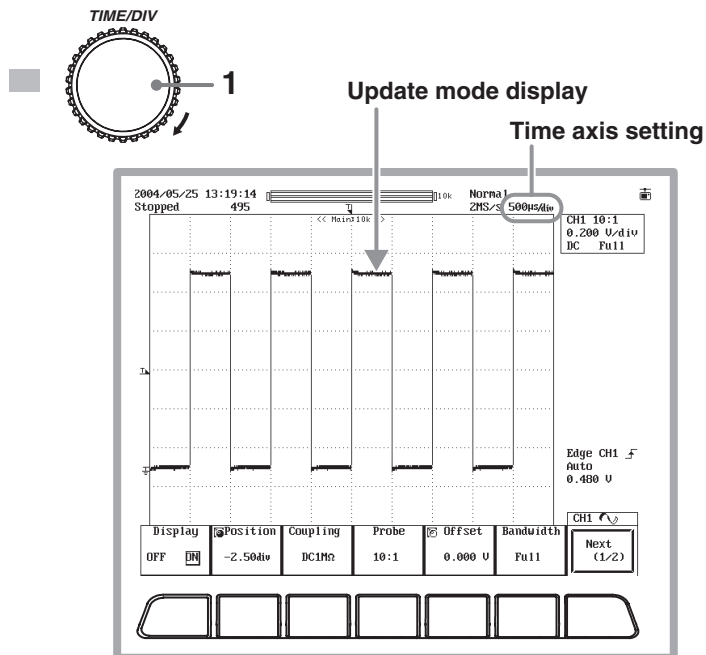

- 1 Turn the TIME/DIV knob clockwise to set the time axis to 500 μ s/div.

Changing Trigger Settings

Trigger settings determine which waveforms of the loaded measurement signals to display, and at which times. The following are the most commonly used trigger settings.

Trigger Types

The two main types of triggers are simple triggers and enhanced triggers. For details, see page 12 of this guide.

Trigger Source

A trigger source is a signal to which trigger activation conditions are applied.

Trigger Slope

The slope of a signal is its movement from a low level to a high level (rising), or from a high level to a low level (falling). When specifying the slope as one of the trigger conditions, it is called the trigger slope. The point at which the slope of the trigger source passes through the trigger level is called the edge.

Trigger Level

This is the level through which the trigger source must pass to activate the trigger. With a simple trigger such as an edge trigger (see page 12 of this guide), the trigger activates if the level of the trigger source passes through a trigger level specified in advance.

Trigger Mode

The trigger mode determines the conditions (such as timing and the number of times) at which the waveform display is updated. If you execute auto setup, the trigger mode is set to auto mode. Five trigger modes are available. For details, see section 6.1 of the user's manual, "Selecting the Trigger Mode."

Trigger Position

When waveform acquisition is started, triggers are activated according to the trigger conditions, and the waveforms loaded into acquisition memory are displayed. By moving the trigger position on the screen, you can change the ratio of data that is displayed before (pre data) and after (post data) the trigger was activated. The initial setting is 50.0% (center screen).

If you initialize the settings or execute auto setup, the trigger type is set to simple (trigger source: CH1, edge trigger).

Edge triggers activate based on the rising, falling, or both, of one input signal.

In the procedure below, the trigger type is left as-is (edge trigger), and the method for changing the trigger slope, trigger mode, and trigger position settings is explained.

Changing the Trigger Slope from Rising to Falling

● ● ● ▶ User's manual section 6.5, "Setting the Edge Trigger (SIMPLE)"

1 SIMPLE

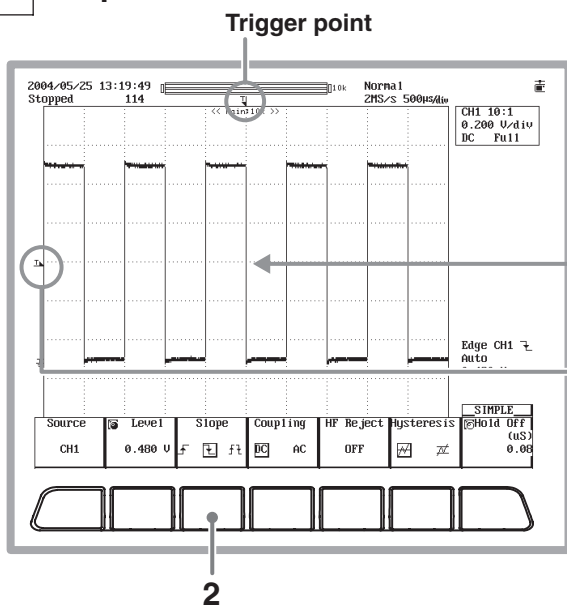

1 Press the SIMPLE key.

2 Open the selection menu, then choose (Falling).

The trigger activates on the falling edge.

Trigger level mark

Shifting the Trigger Position to the Left by Two Divisions

●●●▶  User's manual section 6.2, "Setting the Trigger Position"

By shifting the waveform to the left by just 2 div, the part of the waveform after the trigger (post trigger) becomes much easier to see.

POSITION 1

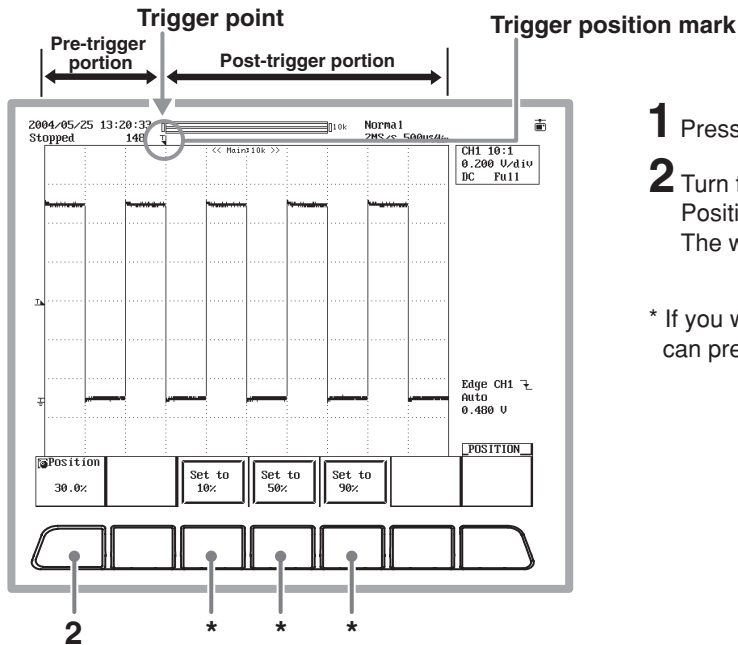

- 1 Press the POSITION key.
- 2 Turn the jog shuttle counterclockwise to set Position to 30.0%.
The waveform shifts 2div to the left.

* If you wish to select 10%, 50%, or 90%, you can press the corresponding soft key.

Changing the Trigger Mode from Auto to Single

●●●▶  User's manual section 6.1, "Selecting the Trigger Mode"

When a trigger activates in Single mode, the waveform display update stops once, and waveform acquisition stops. Single mode is useful for observing single-shot waveforms.

MODE 1

When waveform acquisition stops, the status changes from Running to Stopped.

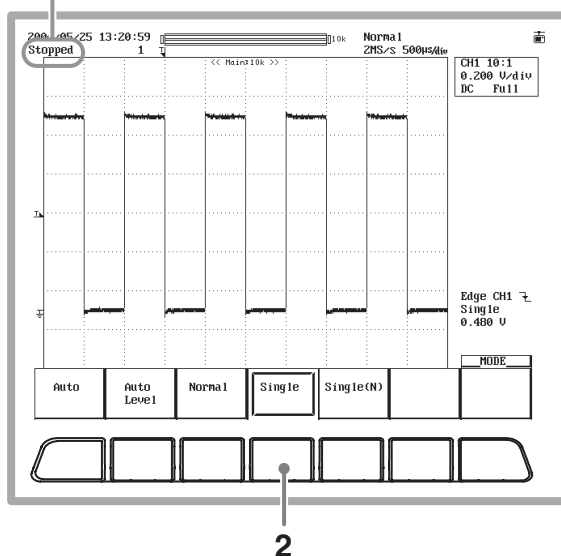

- 1 Press the MODE key.
- 2 Select Single.

Waveform Measurement

This section explains how to use the vertical cursors to measure the voltage and period of the displayed waveform. In addition to cursor measurement, the DL1700E also has functions such as automatic measurement of waveform parameters and computation functions that are useful for taking pulse waveform and other types of measurements.

Measuring Voltage with Vertical Cursors

▶▶▶ User's manual section 10.5, "Cursor Measurements"

The voltage (Y-axis) and time (X-axis) at the position of the cursor is displayed in the lower part of the waveform display frame.

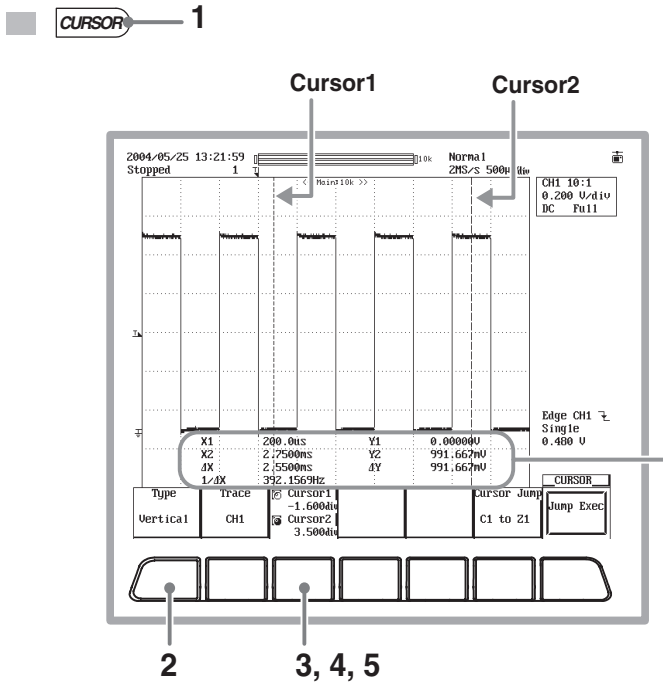

- 1 Press the Cursor key.
 - 2 Open the selection menu, then choose Vertical.
 - 3 Activate the jog shuttle on Cursor1.
 - 4 Turn the jog shuttle to move Cursor1.
 - 5 Move Cursor2 in the same manner.
If you activate the jog shuttle on both Cursor1 and Cursor2, you can move both cursors at the same time.
- X1: X-axis value of Cursor1
 X2: X-axis value of Cursor2
 ΔX: The difference between the X-axis values of Cursor1 and Cursor2
 1/ΔX: The inverse of the difference between the X-axis values of Cursor1 and Cursor2
 Y1: Y-axis value at the cross point of Cursor1 and the waveform
 Y2: Y-axis value at the cross point of Cursor2 and the waveform
 ΔY: The difference between the Y-axis values of Cursor1 and Cursor2

Note

Cursor Types

When not displaying X-Y waveforms

Horizontal cursor	Measures the Y-axis value at the cursor position.
Vertical cursor	Measures the X and Y-axis values at the cursor position.
Marker cursor	Measures the X and Y-axis values of the waveform. The marker cursor moves along the waveform. M1-M4 (markers 1 through 4) can be set on separate waveforms.
Angle cursor	Measurements can be made by converting the time axis values into angles. The zero point (position of reference cursor Ref1) and the end point (position of the reference cursor Ref2) are set on the X-axis and an angle (reference angle) is assigned to the width of Ref1 and Ref2. The positions of the two angle cursors (Cursor1 and Cursor2) can be converted into angles from the specified reference angle and measured.

When displaying X-Y waveforms

Horizontal cursor	Measures the Y-axis value at the cursor position.
Vertical cursor	Measures the X-axis value at the cursor position.
Marker cursor	Measures the X and Y-axis values of the waveform. The marker cursor moves along the waveform.

Zooming a Waveform along the Time Axis

This section describes how to zoom a portion of the displayed waveform along the time axis.

Setting the Zoom Rate

●●●▶ [User's manual section 8.4, "Zooming the Waveform"](#)

You can display two zoomed waveform portions of the original waveform. The portion of the original waveform that is zoomed is shown by the "zoom box."

ZOOM 1

Main waveform display area

Zoom box Z2

Zoom box Z1

1 Press the ZOOM key.

2 Select Main&Z1&Z2.

3 Activate the jog shuttle on Z1 Mag.

4 Turn the jog shuttle to select the zoom factor for Z1.

5 Set Z2 Mag in the same manner.
If you activate the jog shuttle on both Z1 Mag and Z2 Mag, you can set both zoom factors at the same time.

Display frame for zoomed waveform Z2

Display frame for zoomed waveform Z1

2

3, 4, 5

Changing the Zoom Position

●●●▶ [User's manual section 8.4, "Zooming the Waveform"](#)

You can move the zoom position while watching the zoom box.

ZOOM 1

Zoom box Z1

Zoom box Z2

1 Press the ZOOM key.

2 Select Main&Z1&Z2.

3 Activate the jog shuttle on Z1 Position.

4 Turn the jog shuttle to move zoom box Z1.

5 Set Z2 Position in the same manner.
If you activate the jog shuttle on both Z1 Position and Z2 Position, you can set both zoom box positions at the same time.

2

3, 4, 5

Printing and Saving a Waveform

This section describes how to print out the displayed waveform on the built-in printer (when the /B5 option is installed) or save it to a storage medium. You can also print waveforms to a USB or network printer (with the /C10 option installed). Also, you can save data to a built-in storage medium (floppy disk or PC card, one of which can be selected at time of purchase). You can also save to an external USB storage device or network drive (/C10 option).

Printing Screen Images on the Built-In Printer

● ● ● ▶ User's manual section 11.2, "Printing Using the Built-In Printer"

You can print the waveform exactly as it appears on screen. Before printing, follow the procedure in section 11.1 of the user's manual to load roll paper into the built-in printer.

1

1 Press the COPY key.
Printing starts.

Example of a Printout

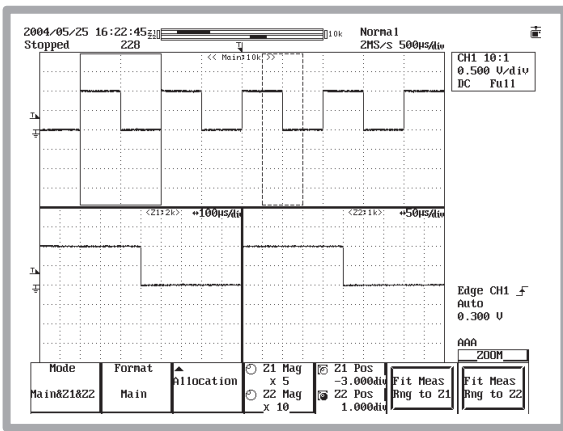

Note

If you press the COPY key while holding down the SHIFT key, the copy menu appears. Though not required for this example, you can enter various print-related settings such as the destination printer (built-in printer, USB printer, or network printer), output format, and comments to be printed beneath the screen image.

COPY menu

Copy to	Format	Information	Comment	COPY
Built-in	Normal	Long	OFF ON	

Saving Screen Image Data to a Storage Medium

● ● ● ▶ User's manual section 12.9, "Saving Screen Image Data"

You can save the waveform displayed on screen to a storage medium as image data.

+ **7**

Press the SHIFT key. The SHIFT indicator illuminates.

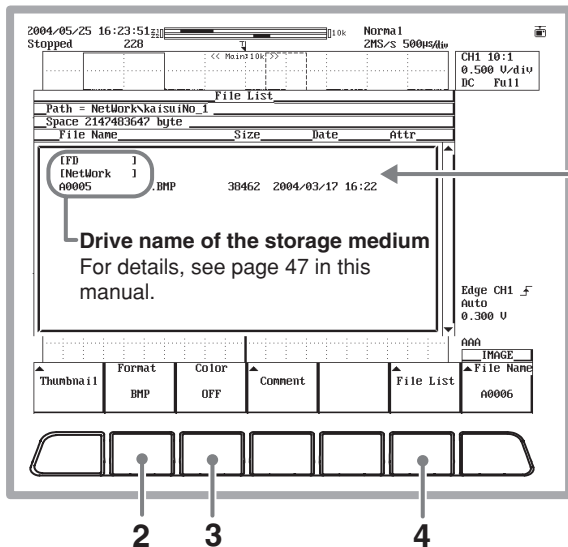

- 1** After pressing the SHIFT key, press the IMAGE SAVE key.
- 2** A menu is displayed in which you can select the output format.
- 3** Select Color mode (if something other than PostScript was selected in step 2).
- 4** Display the File List.
- 5** Turn the jog shuttle to select a save medium.
- 6** Press the SELECT key to enter the desired setting.
- 7** Press IMAGE SAVE again. The image is saved.

Saving Waveform Data to a Storage Medium

●●●▶ User's manual section 12.5, "Saving/Loading the Waveform Data"

You can save the waveform data displayed on screen to a storage medium. When the waveform is saved, its vertical axis, horizontal axis, and trigger settings are also saved.

FILE 1

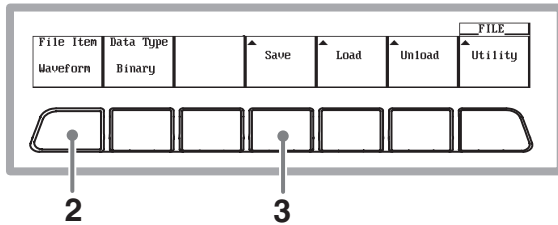

Save menu

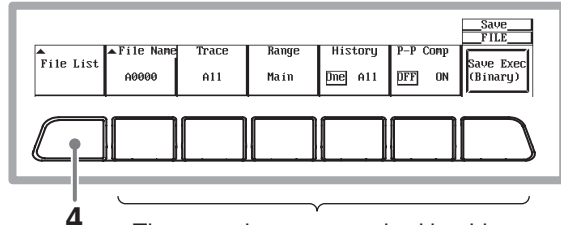

These settings not required by this operation guide, but you can enter them as needed.

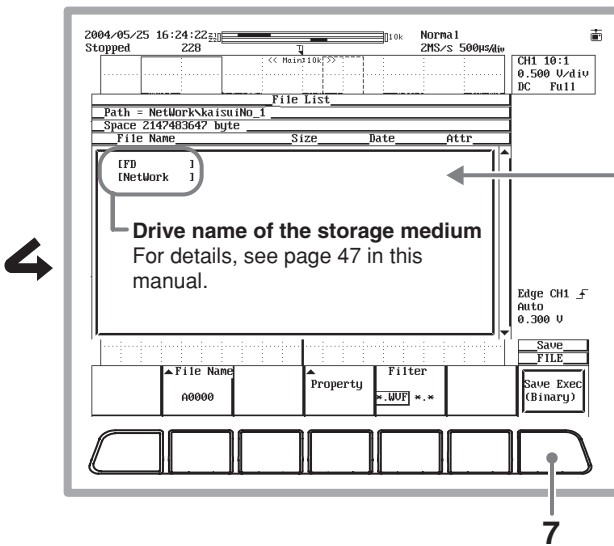

- 1 Press the FILE key.
- 2 Select Waveform (waveform data).
- 3 Display the Save menu.
- 4 Display the File List.
- 5 Turn the jog shuttle to select a save medium.
- 6 Press the SELECT key to enter the desired setting.
- 7 Execute the save.

Tips

Displaying Thumbnails of the Screen Image Data

●●●▶ User's manual section 12.10, "Displaying Thumbnails of Saved Screen Image Data"

You can display thumbnail (miniature) images of the saved screen image data. Thumbnails make it easy to get a visual overview of what data has been saved.

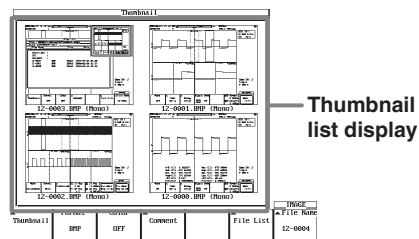
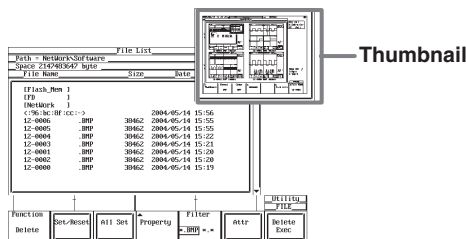

From the FILE or IMAGE menu, select File List > File, then press the SELECT key.

From the IMAGE menu, press the Thumbnail soft key.

Setup Menu Items

For details about specific items introduced in the pages within, refer to the corresponding chapter or section in the user's manual as indicated by the arrows (▶).

CH1 to CH4(2)

CH 1 to CH 4

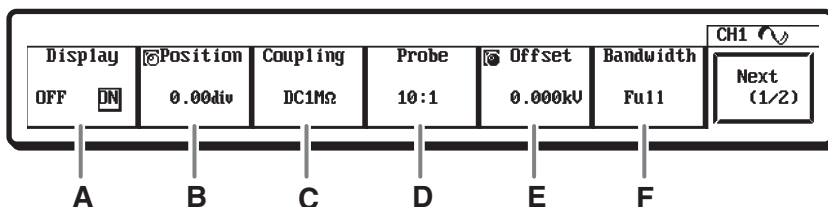

- A** Turn channels ON/OFF ▶ Section 5.1
- B** Position ▶ Section 5.3.
Sets the vertical position of the waveform.
- C** Input coupling ▶ Section 5.4
Selects a method of coupling the input signal to the vertical control circuit of AC or DC. Select GND to confirm the ground level.
- D** Probe attenuation ratio/current-voltage conversion ratio ▶ Section 5.5
According to the type of probe being used, you can select the attenuation ratio (for a voltage probe) or the output rate (for a current probe).
- E** Offset ▶ Section 5.6
You can set the offset voltage to cancel a certain voltage in order to be able to observe only changes in signals at higher voltage axis sensitivities.
- F** Bandwidth limit ▶ Section 5.8
Select the frequency bandwidth of the high frequency components

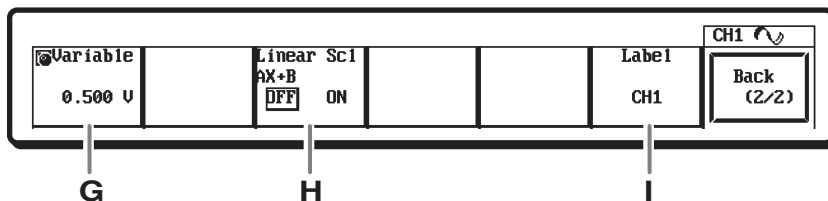

- G** Variable ▶ Section 5.2
The variable command allows the V/div (A/div) values to be set in smaller steps than the setting entered using the V/div knob. It can also be used to expand/reduce the displayed waveform vertically after waveform acquisition.
- H** Turn linear scaling ON/OFF ▶ Section 5.9
You can set the method used to change the scaling of the measured values. Turn linear scaling OFF when not scaling the values.
- I** Enter waveform labels ▶ Section 8.9
You can create waveform labels using up to eight arbitrary characters.

SETUP

SETUP

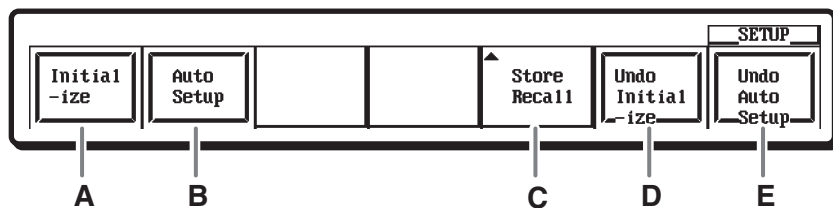

- A Execute initialization** ▶ Section 4.4
Resets the settings to their initial factory default condition.
- B Execute auto setup** ▶ Section 4.5
The auto setup function automatically sets the settings such as V/div, T/div, and trigger level that are appropriate for the input signal.
- C Store/recall** ▶ Section 12.1
Stores/recalls settings.
- D Cancel initialization**
- E Cancel auto setup**

Note

- **Applicable Waveforms for Auto Setup**
Auto setup is available for the following waveforms.
Frequency: approximately 50 Hz or higher
Absolute value of the input voltage : Approximately 20 mV or more when the probe attenuation is 1:1.
Type: repeating wave (non-complex)

ACQ

ACQ

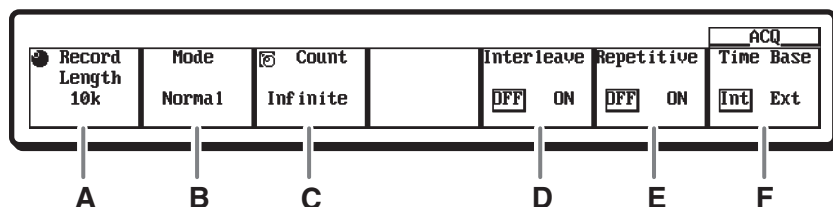

- A Specified record length** ▶ Section 7.2
You can select the number of data points to be stored to the acquisition memory. (10 k = 10000 points)
- B Acquisition mode** ▶ Section 7.5
You can select the method for acquiring waveform data into acquisition memory. Choose from Normal, Envelope, Average, or Box Avg mode.
- C Acquisition count** ▶ Section 7.5
You can set the number of times (the count) to store waveform data to the acquisition memory.
- D Interleave mode** ▶ Section 7.3
This mode allocates the memory of even channels to the odd channels to enable the use of twice the normal memory.
- E Repetitive sampling mode** ▶ Section 7.4
You can choose whether or not to perform repetitive sampling.
- F Time base** ▶ Section 5.10
You can select whether to use an internal or external clock signal from which to obtain a reference period for sampling waveform

Note

- **Acquisition Mode**
 - **Normal**
In this mode, sampled data is stored in the acquisition memory without processing.
 - **Envelope**
Sampling is performed at the maximum sampling rate, then the maximum and minimum values are determined from the data sampled at twice the time interval of normal mode, and the values are stored as pairs in the acquisition memory.
 - **Average**
The instrument takes the exponential or simple average of the waveform data and writes the results to the acquisition memory.
 - **Box Avg**
The moving average of the data sampled at the maximum sampling rate, and the resultant data is stored in the acquisition memory and displayed.

PRESET

PRESET

Select	Type	Probe	V/div	Offset	Trig Lvl	PRESET
A11	CMOS(5V)	10:1	2.00 V	0.00 V	2.50 V	Exec
A	B	C	D	E	F	G

A Preset channels ▶ Section 5.7

You can select the channels on which to set presets from All, or CH1 to CH4(2).

B Preset types

You can select the type of preset to use from CMOS(5V), CMOS(3.3V), ECL, or User.

C Probe attenuation ratio/current-to-voltage conversion ratio

According to the type of probe being used, you can select the attenuation ratio (for a voltage probe) or the output rate (for a current probe).

D V/div value

If the preset type is set to User, you can set the V/div.

E Offset

If the preset type is set to User, you can set the offset voltage used when zooming waveforms in the vertical direction.

F Trigger level

If the preset type is set to User, you can set the passing level of the trigger slope.

G Execute presets

Note

- **Setup after Executing Presets**

The following four types of presets are available.

- **CMOS(5V)**

Input coupling : DC1 M Ω
 Trigger coupling : DC
 V/div : 2 mV/div
 Offset voltage : 0 V
 Trigger level : 2.5 V

- **CMOS(3.3V)**

Input coupling : DC1 M Ω
 Trigger coupling : DC
 V/div : 1 V/div*
 Offset voltage : 0V
 Trigger level : 1.65 V

- **ECL**

Input coupling : DC1 M Ω
 Trigger coupling : DC
 V/div : 200 mV/div*
 Offset voltage : -1.3V
 Trigger level : -1.3 V

- **User**

Input coupling : DC1 M Ω
 Trigger coupling : DC
 V/div : Arbitrary
 Offset voltage : Arbitrary
 Trigger level : Arbitrary

* 2 V/div (2A/div) when the probe attenuation is 1000:1.

SIMPLE

SIMPLE

Source	Level	Slope	Coupling	HF Reject	Hysteresis	Hold Off
CH1	1.50 V	f	DC	AC	OFF	0.00

A
B
C
D
E
F
G

- A Trigger source** ▶ Sections 6.5 to 6.7
You can select a trigger source of input trigger (CH1 to CH4(2)), external input (Ext), or power signal (Line).
- B Trigger level**
Sets the passing level of the trigger slope.
- C Trigger slope**
You can select a slope for the trigger of rising, falling, or both rising and falling.
- D Trigger coupling**
Choose AC when using trigger source signals with the DC component removed, or DC to use the trigger source signal as-is.
- E HF rejection**
Specify if you wish to use a signal as the trigger source that is obtained by removing the high frequency components (frequency components greater than 15 kHz or 20 MHz) from the trigger source signal.
- F Trigger hysteresis**
Sets a hysteresis width to the trigger level so that triggers are not activated by small changes in the trigger signal.
- G Hold off** ▶ Section 6.4
Sets the period to pause trigger detection.

 **Note**

- **Trigger Slope and Trigger Level**

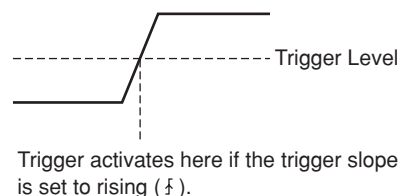

- **Trigger Hysteresis**

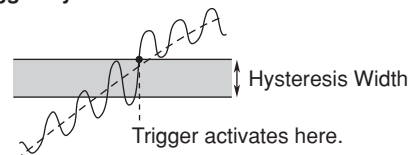

ENHANCED

ENHANCED

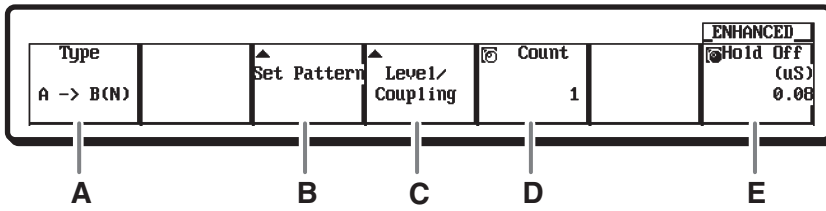

- A Trigger type** ▶ Sections 6.8 to 6.14
You can select the type of enhanced trigger.
- B Pattern setting**
You can set the signal pattern on which the trigger of the selected type will activate.
- C Trigger level/trigger coupling**
Sets the trigger level, trigger hysteresis, trigger coupling, and HF rejection.
- D Number of times condition B is met**
You can select the number of times that condition B should be met from 1 to 10⁸.
- E Hold off** ▶ Section 6.4
Sets the period to pause trigger detection.

Note

- **Enhanced Types**
 - **A->B(N)**
A trigger is activated the nth time condition B becomes true after condition A has become true.
 - **A Delay B**
The trigger activates the first time condition B becomes true after condition A has become true and the specified time has elapsed.
 - **Pattern**
A trigger activates when all of the trigger conditions from several trigger sources become true or not true.
 - **Width**
A trigger activates depending on whether the conditions became true or not for a shorter or longer duration than a specified reference time.
 - **OR**
A trigger activates when at least one of the trigger conditions from several trigger sources is met.
 - **Window**
A trigger activates when a trigger source enters or exits a "window" specified by two voltage levels.
 - **TV**
A trigger activates on the video signal being input to CH1.

MODE(ACTION)

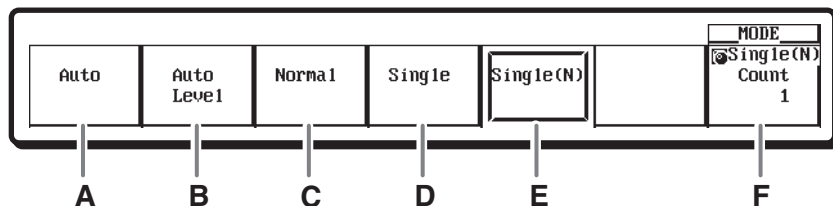
ACTION
MODE

- A Auto mode** ▶ See section 6.1.
If the trigger condition is met within the approximate 100-ms timeout period, the waveform is updated on each trigger occurrence. If the trigger condition is not met after the timeout period elapses, the waveform is automatically updated.
- B Auto level mode** ▶ See section 6.1.
The waveform is displayed in the same fashion as in auto mode, within the timeout period (approximately 1 s). If a trigger is not activated within the timeout period, then the center value of the amplitude of the trigger source is detected, and the trigger level is changed to that value. A trigger is activated using the new value, and the displayed waveforms are updated.
- C Normal mode** ▶ See section 6.1.
The display is updated only when the trigger conditions are met.
- D Single mode** ▶ See section 6.1.
The display is updated once when the trigger conditions are met and the waveform acquisition stops.
- E Single(N) mode** ▶ Section 7.6
When the trigger conditions are met, waveforms are acquired the specified number of times, then acquisition stops. After acquisition is complete, all waveforms are displayed. In this mode, the interval for acquiring waveforms is minimized by not performing other processes such as waveform display until the acquisition of the specified number of waveforms is complete.
- F Single(N) count** ▶ Section 7.6
Sets the number of waveform acquisitions for Single(N) mode.

Note

- Auto Level Mode**
- Single(N) Mode**

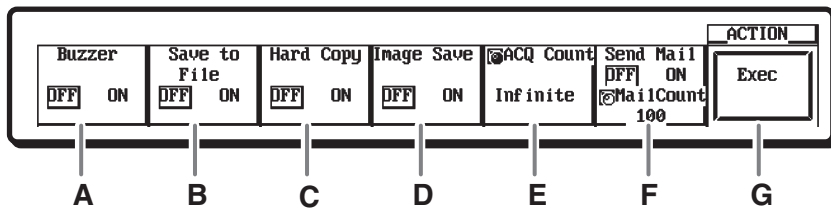

- A Buzzer** ▶ Section 6.15
Select ON to have a buzzer sound every time a trigger activates.
- B Waveform data storage**
Saves waveform data to the destination specified in the FILE menu.
- C Printing screen images**
Prints screen images on the specified printer.
- D Saving screen images**
Saves screen images to the destination specified in the IMAGE SAVE menu.
- E Action count**
You can select the number of times the operation of the action on trigger occurs from 1 to 65536, or Infinite.
- F Sending mail**
Sends mail to the specified mail recipient. You can specify the number of times to send mail.
- G Execute the action on trigger**

POSITION(DELAY)

DELAY
POSITION

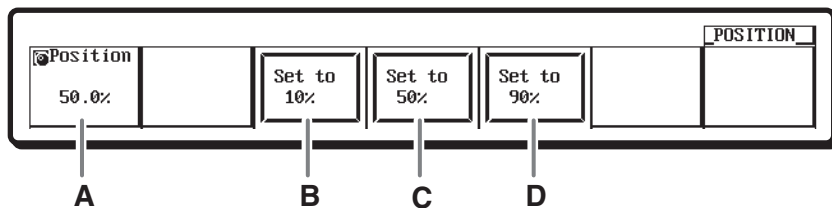

- A Trigger position** ▶ See section 6.2.
You can specify the position of the trigger in terms of a percentage (0 to 100%) of the display record length.
- B To the 10% position**
Sets the trigger to the 10% position along the display record length.
- C To the 50% position**
Sets the trigger to the 50% position along the display record length.
- D To the 90% position**
Sets the trigger to the 90% position along the display record length.

Note

- **Trigger Position**

The diagram illustrates the trigger position relative to the displayed record length. A horizontal line represents the record length from 0% to 100%. A vertical line indicates the trigger position. The region before the trigger is the pre-trigger portion, and the region after is the post-trigger portion. A grid below shows the waveform data points.

SHIFT + DELAY
POSITION

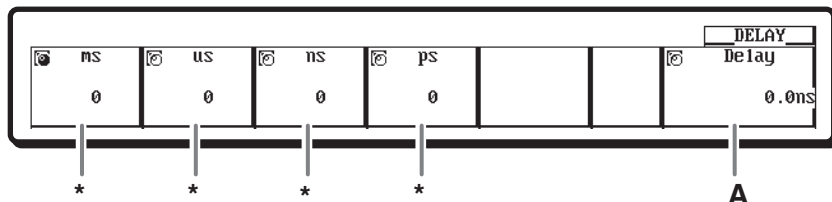

- A Trigger delay** ▶ Section 6.3
Sets a delay such that the waveform occurring the amount of delay after activation of the trigger is displayed.
- * You can set the trigger delay in units of ms, μ s, ns, or ps.

Note

- **Trigger Delay**

Sets the delay in the figure below.

The diagram shows a signal that starts at a 'Trigger point'. After a 'Delay' period, a waveform begins at a point labeled 'T (trigger position)'. The delay is the time interval between the trigger point and the start of the waveform.

DISPLAY(X-Y)

X-Y
DISPLAY

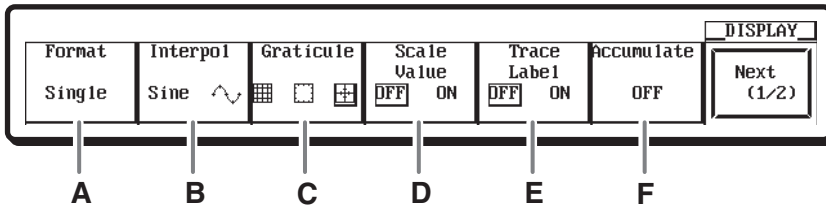

- A Display format** ▶ Section 8.1
Sets the number of divisions into which the screen is split. You can select Single (no division), Dual (two divisions), Triad (three divisions), Quad¹ (four divisions), and Hexa¹ (six divisions).
- B Display interpolation** ▶ Section 8.2
In interpolation areas² where less than 500 points of data exists in ten divisions along the time axis, the waveform is displayed by interpolating between data points. You can select from direct, sine, pulse, or no interpolation (OFF).
- C Graticule** ▶ Section 8.7
You can select from three types of display scales depending on your measurement task.
- D Scale value display ON/OFF** ▶ See section 8.8
You can turn display of the scale values along the vertical and horizontal axis of each channel ON or OFF.
- E Waveform labels ON/OFF** ▶ Section 8.9
You can turn the display of waveform labels ON and OFF.
- F Accumulate display** ▶ Section 8.3
The display time of old waveforms can be set longer than the waveform update period, so that newer waveforms appear overlapped (accumulated) on older waveforms. Select Persist to display each channel in the same color, or Color to display accumulated waveforms in eight different colors according to frequency of the data.

Note

- Interpolation in the Interpolation Area**

1 Quad and Hexa are not available on the DL1720E.
2 Or less than 250 points in ten divisions for Z1 and Z2 when waveforms are zoomed in Main&Z1&Z2.

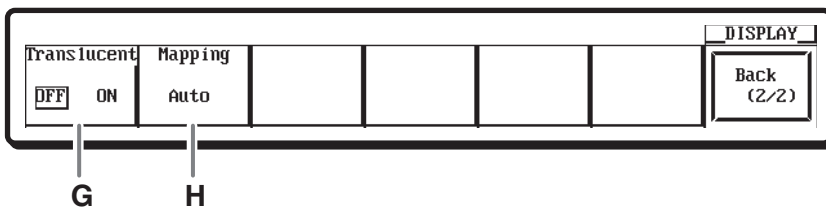

- G Turn translucent display ON and OFF** ▶ Section 8.10
If you select ON, the translucent display is enabled.
- H Waveform mapping** ▶ Section 8.1
You can map the input channels to windows when the screen is divided. Select Auto, Fixed (by number), or User (manual specification).



- The figure below shows the menu used to select T-Y&X-Y for the waveform display format.

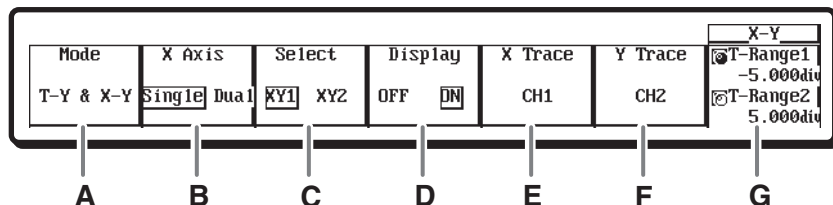

- A Waveform display format** ▶ Section 8.5
Select from T-Y&X-Y (both normal and X-Y waveforms), X-Y (X-Y waveform only), and T-Y (T-Y waveform only).
- B X-axis mode***
Makes the X axis trace common and displays all waveforms whose displays are turned ON for the Y axis (Single), or, sets the X axis trace of XY1 and XY2 separately from the Y axis trace (Dual).
- C Select an X-Y waveform***
Select XY1 or XY2 as the item to be set.
- D Turn X-Y waveform display ON/OFF***
Turns display of the selected X-Y waveform ON or OFF.
- E Select X-axis channels**
You can select channels to be assigned to the X-axis.
- F Select Y-axis channels**
You can select channels to be assigned to the Y-axis.
- G X-Y waveform display range**
You can specify the range of the X-Y waveform to be set using the Y axis range of the T-Y waveform display (-5 to +5 div).

* These menus are not available on the DL1720E.

Note

• When Displaying X-Y Waveforms

- The divided windows of the T-Y waveform display when using the T-Y & X-Y mode are displayed according to Format in the DISPLAY menu.
- The zoom function applies only to T-Y waveforms. In addition, Main, Z1, or Z2 can be selected for the T-Y waveform display.
- To change the position of the X-Y waveform, change the Position setting of each channel.

GO/NO-GO

GO/NO-GO

- The figure below shows the menu used to select the waveform zone for GO/NO-GO determination.

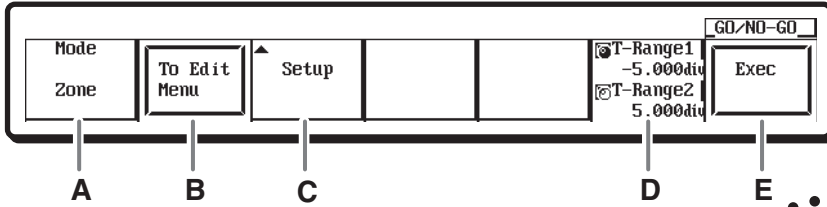

- A GO/NO-GO determination mode** ▶ Section 10.9
Select Zone
- B Creating determination zones**
You can select basic waveforms, create and edit determination zones, and register them.
- C Judgment conditions**
You can set the target waveform, judgment criteria, zone number, determination logic, action conditions, and action after determination.
- D Determination range**
Sets a determination start and stop point when specifying a limited range of determination along the time axis.
- E Execute determination**

Note

- GO/NO-GO Determination Modes**
The GO/NO-GO function is useful when you want to inspect signals and track down abnormal symptoms on a production line making electronic equipment. The function determines whether the waveform is within the preset range and performs a predetermined action when the decision is NO-GO*. The following two determination modes are available.
- Zone**
A determination zone is created based on a reference waveform, and GO/NO-GO is determined according to whether the waveform exits or enters the determination zones.
- Parameter**
Sets the upper and lower limit values for automatic measurement of waveform parameters, then determines GO/NO-GO based on whether the waveform is between or outside of those values.
* A NO-GO determination is made when the conditions

- The figure below shows the menu used to select the measured values of waveform parameters for GO/NO-GO determination.

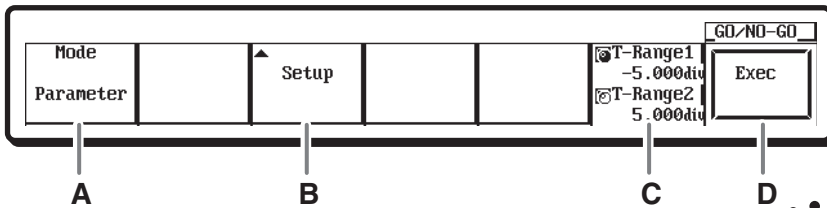

- A GO/NO-GO determination mode** ▶ Section 10.10
Selects the measured values of waveform parameters.
- B Judgment conditions**
You can set the target waveform, judgment criteria, parameters, upper and lower limit action conditions of the parameters, and action after determination.
- C Determination range**
Sets a determination start and stop point when specifying a limited range of determination along the time axis.
- D Execute determination**

Note

- Action after NO-GO determination**
 - Buzzer**
Sounds a buzzer.
 - Save waveform data (Save to File)**
Saves waveform data to the destination specified in the FILE menu in binary, ASCII, or floating point format.
 - Print Screen Image (Hard Copy)**
Prints screen images on the printer specified in the COPY menu.
 - Save Screen Images (Image Save)**
Saves screen images to the destination specified in the IMAGE SAVE menu.
 - Mail transmission (Send Mail)**
Sends mail to the specified mail recipient (with the /C10 option).

MEASURE

MEASURE

- The figure below shows the menu used to turn ON automated measurement of waveform parameters.

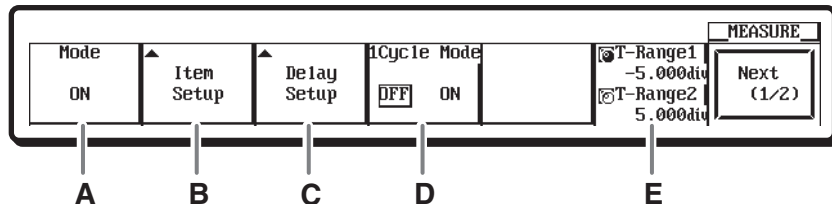

A Turn automated measurement of waveform parameters

ON/OFF ▶ Section 10.6

Select ON to automatically measure waveform parameters.

B Measurement parameters

Select the desired parameters for automatic measurement and the target waveform.

C Delay

Used for entering settings related to measurement of delay between channels.

D Turn 1 cycle mode ON and OFF

This mode is used to determine the waveform cycle and whether or not to calculate measurement values related to the vertical axis or area within the cycle. This is relevant to Rms, Avg, and other parameters.

E Measurement range

You can set the range on the time axis for automatic measurement of waveform parameters.

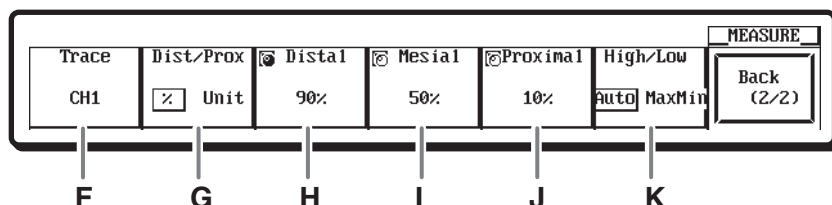

F Distal, mesial, or proximal target waveform

Select the waveform used to determine the distal, mesial, and proximal values that serve as the criteria for automatic measurement of waveform parameters.

G Units of distal, mesial, and proximal values

Select % or voltage.

H Distal value

Sets the distal value in terms of a percentage or by voltage value.

I Mesial value

Sets the mesial value in terms of a percentage or by voltage value.

J Proximal value

Sets the proximal value in terms of a percentage or by voltage value.

K High/Low level

You can select the method for setting the High and Low levels. You can choose from Auto, in which the high and low ends of the amplitude are set to High and Low respectively, or MAX-MIN in which the maximum and minimum values are used.

Note

• Measurement Parameters Related to the Voltage Axis

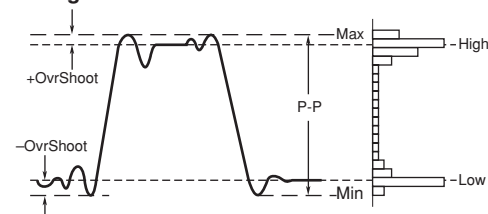

• Measurement Parameters Related to the Time Axis

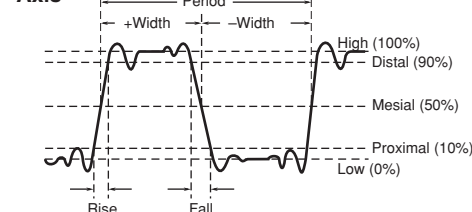

MEASURE

- The figure below shows the menu used to select cycle statistics (measurement per cycle or statistics processed within the measurement range) for the mode.

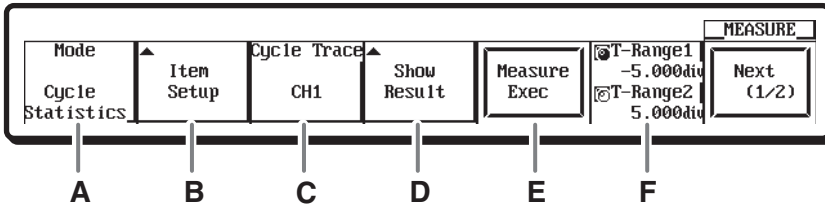

- A Statistical processing type** ▶ Section 10.7
Select Statistics for normal statistical processing, Cycle Statistics for measurement per cycle and statistical processing within the measurement range, or History Statistics for measurement or statistical processing of history waveforms.
- B Measurement parameters**
Select the desired parameters for statistical processing and the target waveform.
- C Cycle trace¹**
Select the waveform used to determine the cycle.
- D Results list display²**
Displays a list of measured results of the selected parameters for automatic measurement.
- E Execute statistical processing³**
- F Measured range**

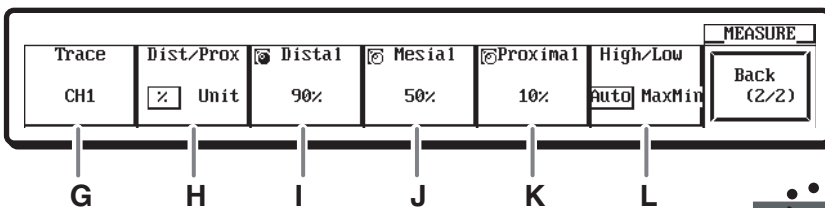

- G Distal, mesial, or proximal target waveform**
Select the waveform used to determine the distal, mesial, and proximal values that serve as the criteria for automatic measurement of waveform parameters.
- H Units of distal, mesial, and proximal values**
Select % or voltage.
- I Distal value**
Sets the distal value in terms of a percentage or by voltage value.
- J Mesial value**
Sets the mesial value in terms of a percentage or by voltage value.
- K Proximal value**
Sets the proximal value in terms of a percentage or by voltage value.
- L High/Low level**
You can select the method for setting the High and Low levels. You can choose from Auto, in which the high and low ends of the amplitude are set to High and Low respectively, or MAX-MIN in which the maximum and minimum values are used.

Note

- **Statistical Processing**
Performs statistical processing on the automatically measured values of waveform parameters. The following five statistics can be determined on the two measured values of automated measurement parameters.
 - Max: Maximum
 - Min: Minimum
 - Avg: Average
 - Sdv: Standard deviation
 - Cnt: Number of automatically measured values used in the statistical processing.
 The following three statistical processing methods are available.
- **Normal Statistical Processing**
Statistical processing is performed on all acquired waveforms while acquiring waveforms.
- **Measurement Per Cycle/Statistical Processing within the Measurement Range**
Performs automated measurement of waveform parameters on the waveforms in the specified measuring range every cycle.
- **Measurement and Statistical Processing of History Waveforms**
Performs statistical processing on automatically measured parameters of the waveform acquired using the history memory function. Statistical processing is performed from the oldest data.

CURSOR

CURSOR

- The figure below shows the menu used to select Vertical for the cursor type.

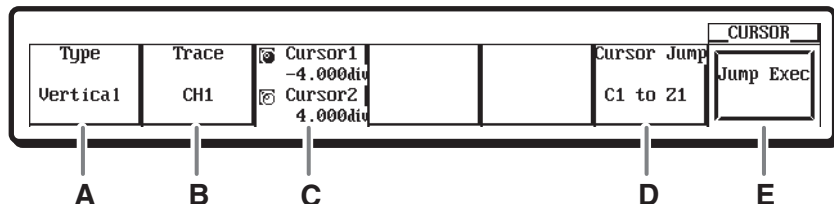

- A Cursor type** ▶ Section 10.5
You can select a cursor of H (horizontal), V (vertical), Marker, or Angle (degree).
- B Target waveform**
Selects the waveform to be measured with the cursor.
- C Move the cursor**
You can set the positions of two V cursors.
- D Cursor jump select**
Selects the type of jump to be used for moving the cursor.
- E** Selects the type of jump to be used for moving the cursor.

* When X-Y waveforms are displayed, Degree (angle) cursors are not available.

- The figure below shows the menu used to select Marker for the cursor type.

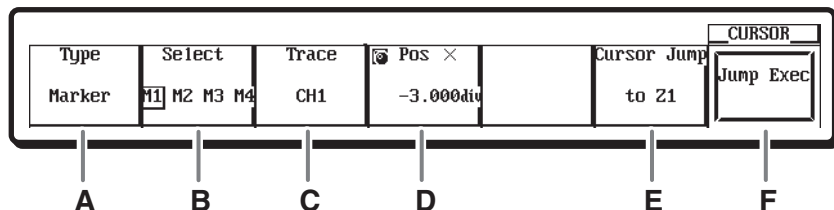

- A Cursor type** ▶ Section 10.5
You can select a cursor of H (horizontal), V (vertical), Marker, or Degree (angle).
- B Select marker**
You can select the marker to move.
- C Target waveform**
Selects the waveform to be measured with the cursor.
- D Move the marker**
Sets the position of the marker.
- E Marker jump select**
Selects the type of jump to be used for moving the marker.
- F Execute marker jump**

* When X-Y waveforms are displayed, Degree (angle) cursors are not available.

Note

- Cursor Types**
 - H (Horizontal) Cursors**
Two broken lines (horizontal cursors) are displayed parallel to the horizontal axis (X-axis). The voltage value of each H cursor and the difference in voltage between the cursors can be measured.
 - V (Vertical) Cursors**
Two broken lines (V cursors) are displayed parallel to the vertical axis (Y-axis). The time from the trigger position to each V cursor and the time difference between the cursors can be measured. In addition, the voltage value of the signal at each cursor position and the difference in voltage between the cursors can be measured.
 - Marker Cursors**
Four markers are displayed on the specified waveform. The voltage at each marker, the time from the trigger position, and the voltage and time difference between markers can be measured.
 - Angle (Degree) Cursors**
The zero point and the end point are set on the X-axis and a reference angle is assigned to the width of the two points. The positions of the two angle cursors can be converted into angles from the specified reference angle and measured.

MATH

MATH
PHASE

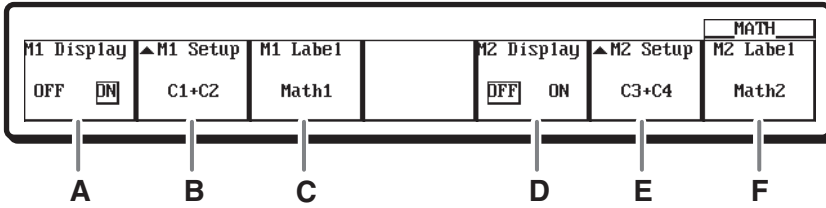

A Turn display of computed waveform M1 ON and OFF

▶ Chapter 9
Selects whether or not to display M1.

B M1 computation setting

You can specify a computation definition, the channels to be computed, scaling, units, and smoothing.

C M1 label
Enters the label.

D Turn the display of computed waveform M2 ON and OFF
Selects whether or not to display M2.

E M2 computation setting

You can specify a computation definition, the channels to be computed, scaling, units, and smoothing.

F M2 label
Enters the label.

Note

- Waveform Computation Example**

Addition (+)

Subtraction (-)

HISTORY

HISTORY

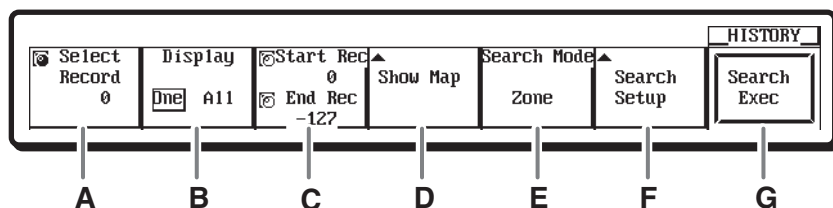

- A Select the displayed waveform** ▶ Section 10.1
You can select waveforms to display from the data stored previously in the acquisition memory (history waveforms).
- B Waveform display format** ▶ Section 10.1
Select a waveform display format of One or All.
- C Start/end record** ▶ Section 10.1
Specify the range of history waveforms to be displayed.
- D History map list display** ▶ Section 10.1
Lists the number and acquisition time of the waveform data stored in acquisition memory.
- E Search mode** ▶ Sections 10.2 and 10.3
You can select Zone to search for history waveforms passing or not passing through a specified search zone (zone search), or Parameter to search for ones that meet or do not meet specified parameter conditions (waveform parameter search).
- F History search conditions** ▶ Sections 10.2 and 10.3
Sets zone search conditions (the search zone, target waveform, search status, range, and other parameters), or waveform parameter search conditions (search parameters, target waveform, search status, search logic, range, and other parameters).
- G Execute history search** ▶ Sections 10.2 and 10.3

Note

- **Waveform Display Format**

- **One**

Displays only the waveform specified in Select Record from the range specified by the Start Record and End Record.

- **All**

Displays accumulated all the waveforms in the range specified by Start Record and End Record.

- **Zone Search**

History waveforms Search zone

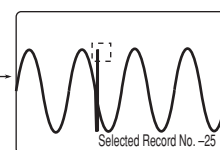
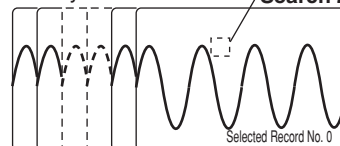

- **Waveform Parameter Search**

History waveform

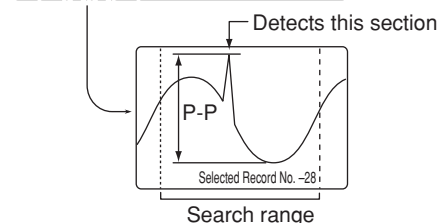
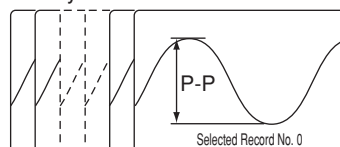

Search parameter: P-P
Status of the search parameters for the searched waveform: OUT

ZOOM(SEARCH)

SEARCH

ZOOM

- The figure below shows the menu used to select Main & Z1 & Z2 for the waveform display method of the zoomed waveform.

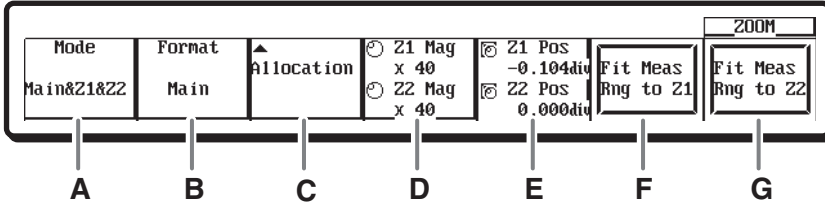

A Select the display method for zoomed waveforms

▶ Section 8.4

You can select how to display main waveform and the two zoom waveforms (Z1 and Z2).

- B** Sets the number of divisions into which the screen is split. You can select Main, Single (no division), Dual (two divisions), Triad (three divisions), Quad* (four divisions), and Hexa* (six divisions).
- C** Select the zoom target waveform
Select the waveforms to zoom-display. You cannot select waveforms whose display is turned OFF.
- D Zoom rate**
Sets the zoom rate (T/div) for the Z1 or Z2 zoom display.
- E Zoom position**
The zoom position can be set by specifying the zoom center position (center of the zoom box) in the range of -5 to +5 divisions with the center of the waveform display frame set to 0 divisions.
- F** Change Z1 range of automated measurement of waveform parameters
Sets the measurement range of the automated measurement of waveform parameters to the zoom range of Z1.
- G** Change Z2 range of automated measurement of waveform parameters
Sets the measurement range of the automated measurement of waveform parameters to the zoom range of Z2.

Note

• Selecting the Display Method for Zoomed Waveforms

Select from the following.

- **Main**
Displays only the main (unzoomed) waveform.
- **Z1 Only**
Displays only the zoomed waveform of zoom box Z1.
- **Z2 Only**
Displays only the zoomed waveform of zoom box Z2.
- **Main&Z1**
Displays the main waveform in the top window and zoomed waveform of zoom box Z1 in the bottom window.
- **Main&Z2**
Displays the main waveform in the top window and zoomed waveform of zoom box Z2 in the bottom window.
- **Z1&Z2**
Displays the zoomed waveform of zoom box Z1 in the top window and the zoomed waveform of zoom box Z2 in the bottom window.
- **Main&Z1&Z2**
Displays the main waveform in the top window, the zoomed waveform of zoom box Z1 in the lower left window and the zoomed waveform of zoom box Z2 in the lower right window.

* Quad and Hexa are not available on the DL1720E.

SHIFT

+

SEARCH

ZOOM

- The figure below shows the menu used to select Edge for the search method.

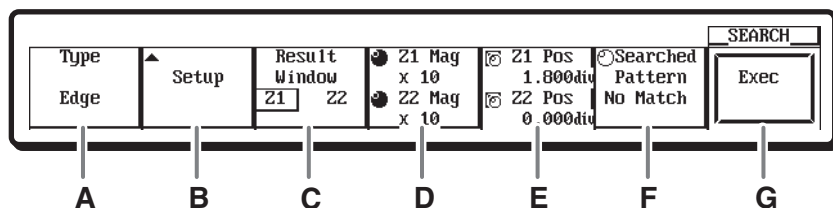

A Select the search method ▶ Section 10.4

You can choose Edge in which a search is performed based on the number of times the waveform goes from the search start point to a point above or below (rising or falling) a specified level.

B Edge search conditions

You can set the search target waveform, search start point, level, search count, and other parameters.

C Window for displaying the found waveform*

Select Z1 or Z2 as the window for displaying the found waveform.

D Zoom rate

Sets the zoom rate (T/div) for the Z1 or Z2 zoom display.

E Zoom position

The zoom position can be set by specifying the zoom center position (center of the zoom box) in the range of -5 to +5 divisions with the center of the waveform display frame set to 0 divisions.

F Display of past search results

Select the number of the search result to display.

G Execute the search

* This option is only displayed when the zoom waveform display

Note

• Search Methods

Select from the following.

• Edge

Performs a search based on the number of times that a waveform falls below or above (rising/falling) a specified level.

• Serial Pattern

Performs a search based on whether the serial status pattern of the waveform (the status pattern of the waveform that changes over time) is High (H), Low (L), or Don't care (X), and whether it is the same as a specified pattern.

• Parallel Pattern

Performs a search based on whether the parallel status pattern of the waveform (the status pattern of the waveforms at the same point in time) is High (H), Low (L), or Don't care (X), and whether it is the same as a specified pattern.

• Pulse Width

Searches for waveform pulses lying above or below a specified level whose widths are of shorter or longer duration than a specified time.

• Auto Scroll

The zoom position automatically moves in the specified direction. You can confirm the zoomed waveform and stop the scroll operation at an arbitrary position.

- The figure below shows the menu used to select Auto Scroll for the search method.

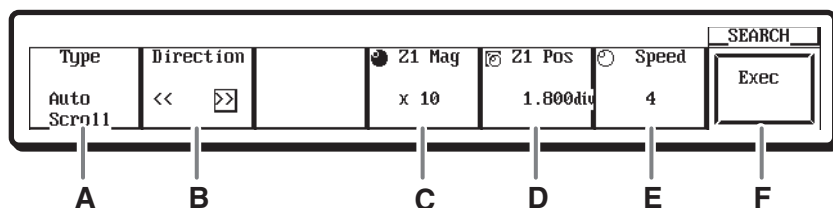

A Select the search method ▶ Section 10.4

You can select Auto Scroll in which the zoom position is automatically moved in the specified direction.

B Select the scroll direction

Selects whether to scroll to the right or left.

C Zoom rate

Sets the zoom rate (T/div) for the Z1 or Z2 zoom display.

D Zoom position

The zoom position can be set by specifying the zoom center position (center of the zoom box) in the range of -5 to +5 divisions with the center of the waveform display frame set to 0 divisions.

E Scroll speed

You can select a speed from 1 to 10.

F Execute the search

COPY

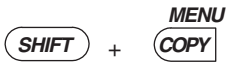

- The figure below shows the menu used to select the built-in printer as the destination printer.

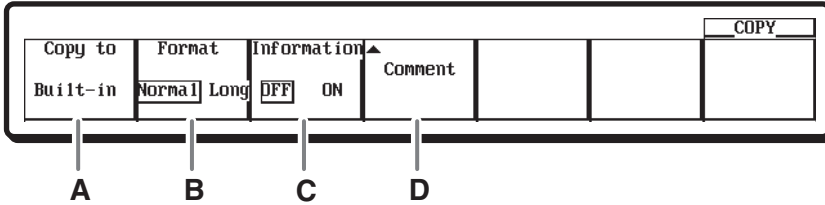

- A Destination printer** ▶ Sections 11.2 to 11.4
You can select a printer for printing screen images of built-in printer, USB printer, or network printer.
- B Output format**
You can select Normal for standard-sized printouts, or Long for printouts of expanded waveforms.
- C Additional information**
Setup data can be printed simultaneously with the waveform.
- D Comment**
Lets you enter comments to be printed below the screen image.

* To print, press the COPY key.

- The figure below shows the menu used to select the USB printer as the destination printer.

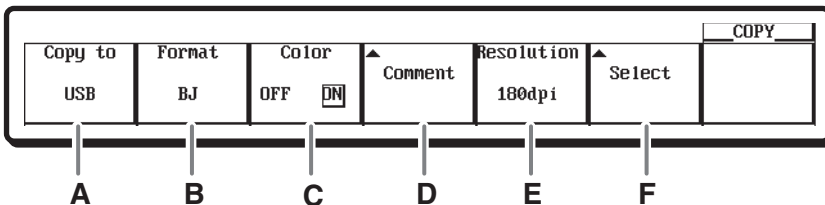

- A Destination printer** ▶ Sections 11.2 to 11.4
You can select a printer for printing screen images of built-in printer, USB printer, or network printer.
- B Output format**
You can select a format of ESC-P, ESC-P2, LIPS3, PCL5, or BJ to output to the USB printer.
- C Turn color printing ON and OFF**
- D Comment**
Lets you enter comments to be printed below the screen image.
- E Output resolution for BJ printers (when BJ is selected as the output format)**
You can choose from 180 dpi, 300 dpi, 360 dpi, or 600 dpi.
- F Check the connected USB printer**

* To print, press the COPY key.

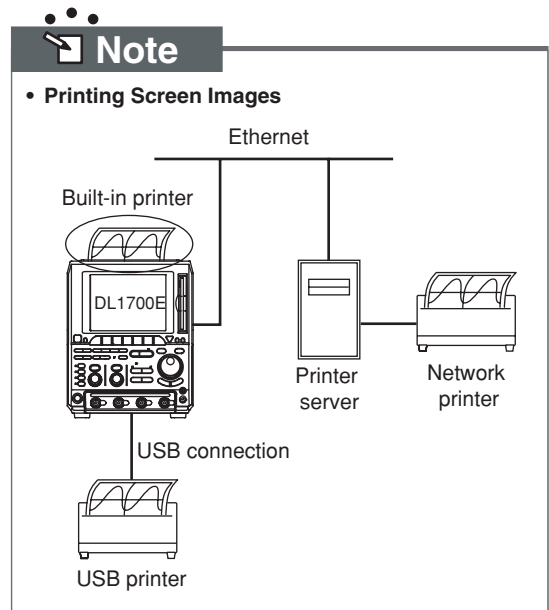
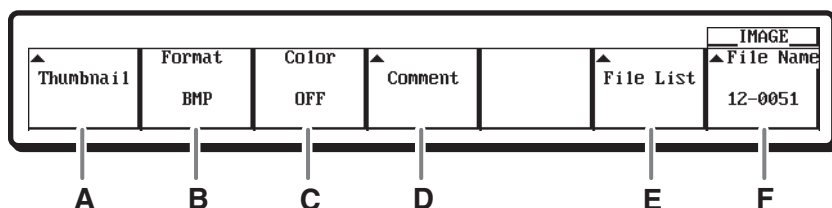

IMAGE SAVE

SHIFT + **MENU**
IMAGE SAVE



- A** Thumbnail list ▶ Section 12.10
Displays a list of thumbnails of the saved screen images.
 - B** Output format ▶ Section 12.9
You can select a format for saving screen images of TIFF, BMP, PS, PNG, or JPEG.
 - C** Color ▶ Section 12.9
You can select a color scheme to use when saving screen images of Color, Color (white background), Grayscale, or Black and White.
 - D** Comments ▶ Section 12.9
Lets you add comments to be printed in the lower part of the screen.
 - E** Save destination* ▶ Section 12.9
The drive names of the available storage media are displayed in the File List window. You can specify the destination drive and directory for saving data. To execute the save, simply press IMAGE SAVE.
 - F** File name ▶ Section 12.9
Use to enter a file name. Files can be named automatically (auto naming) by number or date/time.
- * To save screen images, press IMAGE SAVE.

Note

- Example of Displaying Saved Thumbnails of Screen Images

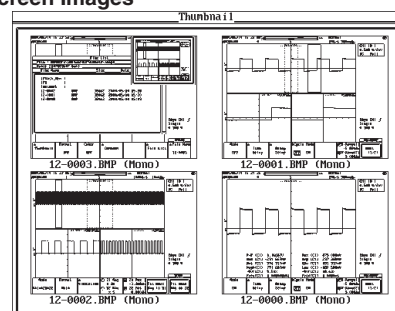

- Names of Storage Media

[FD]: Floppy disk
[PC Card]: PC card
[USB]: USB storage
[NetWork]: Network drive

FILE

FILE

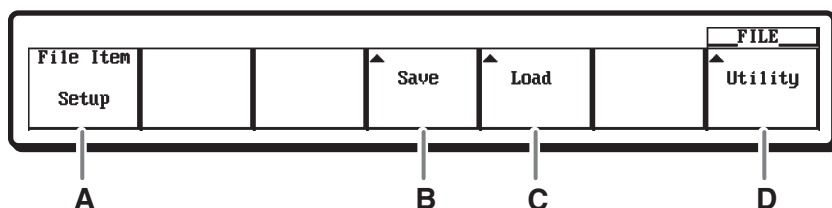

- A** Data selection ▶ Sections 12.5 to 12.8
Select the type of data to save or load. You can choose from setup data, waveform data, snapshot waveform data, automatic measurement values of waveform parameters, and screen image data.
- B** Saving ▶ Sections 12.5 to 12.9
You can enter settings such as the items to save, save method, and save destination, and execute the save.
- C** Loading Sections ▶ Sections 12.5 to 12.7
You can enter load settings and execute the load.
- D** File operations ▶ Sections 12.4, and 12.11 to 12.13
Perform such operations as file deletion, copying, renaming files and directories, and initializing storage media.

Note

- Save Format for Waveform Data (Data Type)
You can select from binary, ASCII, or 32-bit floating.

MISC

MISC

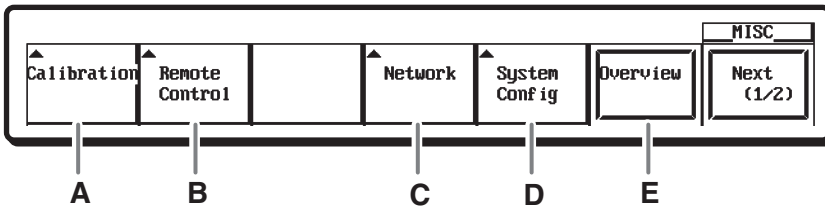

- A Calibration** ▶ Sections 4.6 and 4.7
You can execute calibration, turn auto calibration ON and OFF, and enter settings related to input signal delay time correction.
- B Communication interface***
Select a communications interface of GP-IB, USB, or Network (Ethernet). When you select GP-IB, you can also enter settings required for that protocol.
- C Network** ▶ Chapter 13
Lets you enter TCP/IP settings that are required for an Ethernet connection with the instrument.
- D System settings** ▶ Sections 3.6, 5.6, 6.16, and 15.1 to 15.3
You can enter settings for the date and time, menu and message language, click sound ON/OFF, offset cancel ON/OFF, and the trigger gate settings.
- E Overview** ▶ See section 16.4
Displays the model name, record length, built-in storage media drive type, options, default language, software version number, and other information about the instrument.

* For details, see the Communication Interface User's Manual.

Note

- **Communications Using the Ethernet Interface**
The following are possible.
 - Saving, deleting, and copying waveform data, screen images, and setup data to and from an FTP server on the network.
 - The DL1700E can be accessed from an FTP client on the network, and the files on the built-in storage medium or external USB device can be retrieved.
 - Printing screen images to a network printer.
 - Information from the instrument such as its status or GO/NO-GO determination results can be transmitted periodically in an e-mail message to a specified mail address.
 - The DL1700E can function as a Web server. From the DL1700E Web page, you can transfer files, monitor the displayed waveform, perform basic key operations on the instrument, and obtain waveform data.

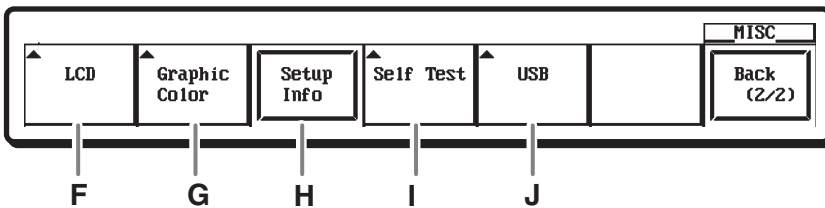

- F LCD backlight** ▶ Section 15.5
Turns the LCD display backlight ON or OFF, and sets the backlight's brightness (eight settings from 0 to 7).
- G Screen color and intensity** ▶ Section 15.4
You can enter the color and intensity of each part of the screen.
- H List of setup data**
Setup data related to the vertical axis, trigger, and horizontal axis of CH1 to CH4(2) is displayed in a list.
- I Self test** ▶ Section 16.3
You can perform tests of the memory, keys, the floppy disk drive, the PC card, the built-in printer, and accuracy.
- J USB** ▶ Sections 4.3, 11.3, and 12.3
You can display a list of USB devices connected to the instrument, and set the language of the USB keyboard.